

FALCON & FALCON XL USER'S GUIDE

MOTION SENSORS FOR INDUSTRIAL DOORS

- **FALCON:** for high mounting
- **FALCON XL:** for low mounting

TECHNICAL SPECIFICATIONS

Technology: Microwave and microprocessor
Transmitter frequency: 24.125 GHz
Transmitter radiated power: <20 dBm EIRP
Transmitter power density: < 5 mW/cm²
Mounting height
 FALCON: from 11.5 to 23'
 FALCON XL: from 6.5 to 11.5'
Tilt angle: 0° to 180° in elevation
Detection zone (typical)
 Wide pattern (FALCON XL): 13' (W) x 6.5' (D)
 for a mounting height of 8.2'
 Narrow pattern (FALCON): 13' (W) x 16' (D)
 for a mounting height of 16'
Detection mode: movement
Minimum detection speed: 2.2 in/s (measured in the sensor axis)
Supply voltage: 12V to 24V AC +/- 10%
 12V to 24V DC +30% / -10%
Mains frequency: 50 to 60 Hz
Power consumption: < 2W
Output relay: free of potential changeover contact
 Max contact voltage : 42V AC/ DC
 Max contact current: 1A (resistive)
 Max switching power: 30W (DC) / 60 VA (AC)

Hold time: 0.5s to 9s (adjustable)
Manual adjustment:

- orientation of sensing field (mechanically)
- multiple functions (by push buttons).

Remote control adjustments:

- Sensitivity.
- Hold time.
- Detection mode.
- Pedestrian and parallel traffic rejection mode.
- Relay configuration.

Temperature range : -22°F to 122°F (-30°C to +60°C)
Degree of protection: IP65
Product conformity:
 R&TTE 1999/5/EC
 EMC 89/336/EEC
Dimensions : 5 in (D) x 4 in (W) x 3 3/4 (H)
 (127mm (D) x 102 mm (W) x 96mm (H))
Weight: 0.88 lbs (400 g)
Housing Material: ABS and Polycarbonate
Bracket Material: black anodized aluminum
Cable length: 33 ft (10 m)
Cable diameter: 1/8" (3 mm) (minimum)
 1/4" (6.5 mm) (maximum)

DESCRIPTION OF THE SENSOR

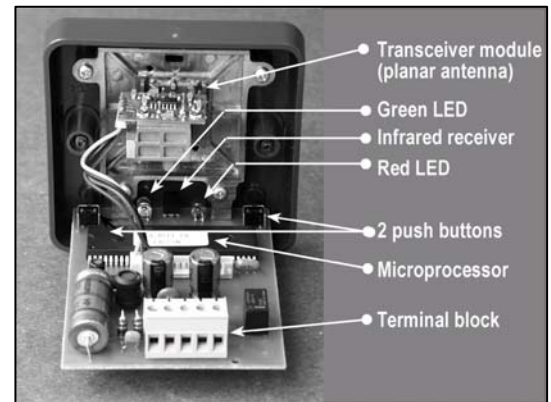
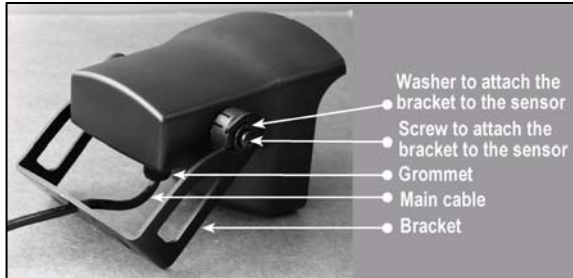
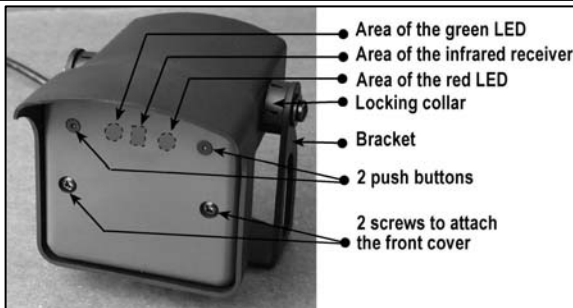

INSTALLATION TIPS

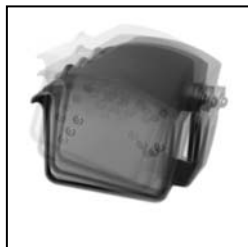

The sensor must be firmly fastened in order not to vibrate.



The sensor must not be placed directly behind a panel or any kind of material.

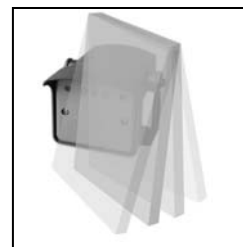

The sensor must not have any object likely to move or vibrate in its sensing field.



The sensor must not have any fluorescent lighting in its sensing field.

WIRING

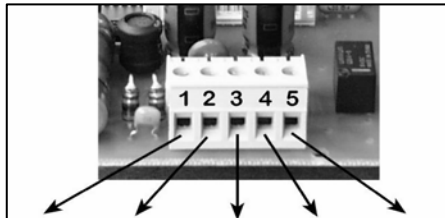

US Wire Color: Red Black White Green Yellow
 12-24 VAC/DC COM NO NC

European Wire Color: Brown Green White Yellow Gray

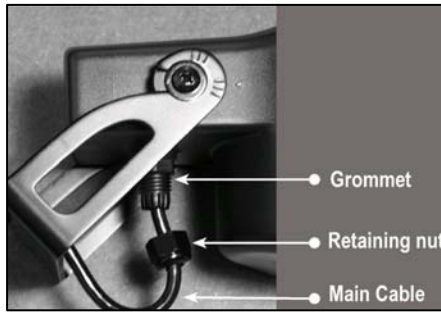

To remove or to insert the cable:

- Unscrew the retaining nut;
- Pass the cable through the grommet and the retaining nut.
- Tighten the retaining nut.

OPENING AND CLOSING THE SENSOR

Opening the sensor

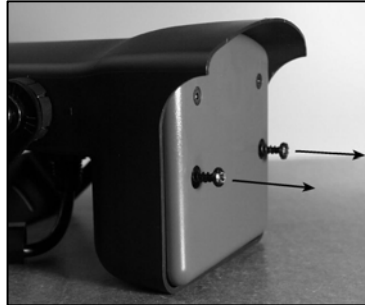

- Loosen the retaining nut until the cable slides easily into the grommet;
- Partially unscrew the 2 front cover screws;
- Pull out the front cover with the 2 front cover screws.

Closing the sensor

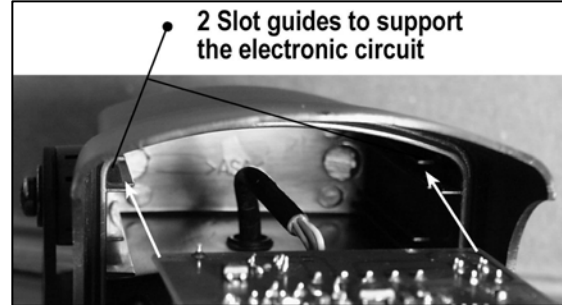

- Connect the quick disconnect terminal block to the main electronic circuit;
- Slide the main electronic circuit into the 2 housing slot guides;
- Gently push the front cover and make sure that the external housing is properly seated (front cover must be flush with housing).
- Screw the 2 front cover screws and tighten the retaining nut.

SENSOR DIMENSIONS AND MOUNTING

Ceiling Mounting

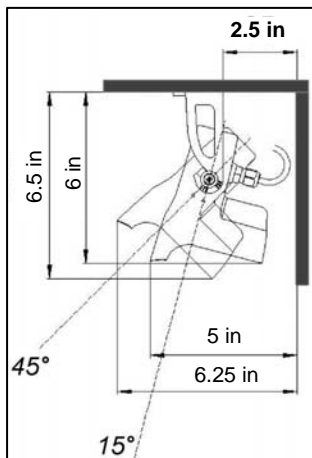

Wall Mounting

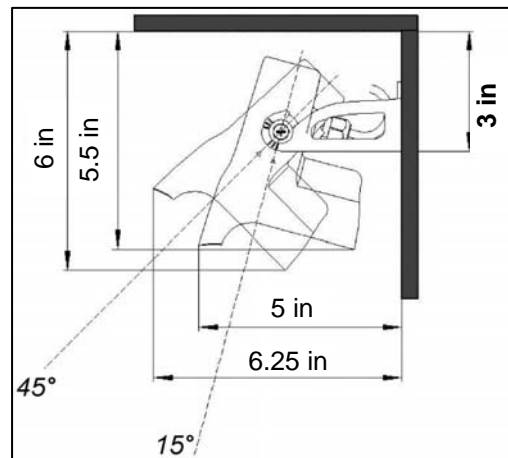

Remark: The bold-type values give the minimum distance required to be able to fully adjust the sensor.

BRACKET MOUNTING

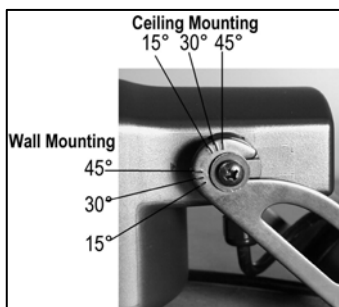

- Check that both locking collar are at the same angle;
- Align the bracket slot to the locking collar guide as shown.

SETTING
THE SENSING
FIELD
DIMENSIONS

FALCON (Mounting height: 16.5 feet)

The sensing fields here on the right correspond to the following adjustments:

- tilt angle: 15°, 30°, 45°
- sensitivity: 9.

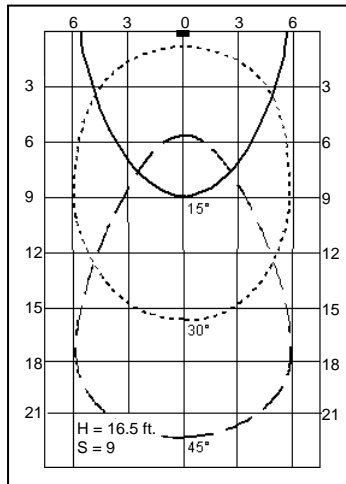

The sensing fields here on the right correspond to the following adjustments:

- tilt angle: 30°
- sensitivity: 9, 6, 3

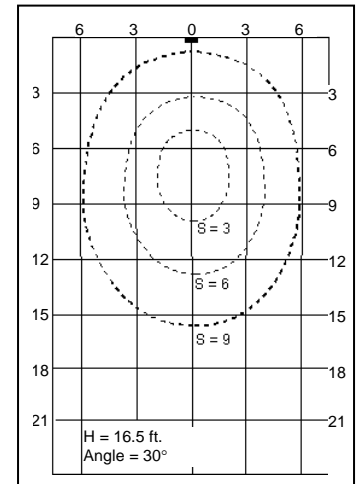

FALCON (Mounting height: 11.5 feet)

The sensing fields here on the right correspond to the following adjustments:

- tilt angle: 15°, 30°, 45° ;
- sensitivity: 9.

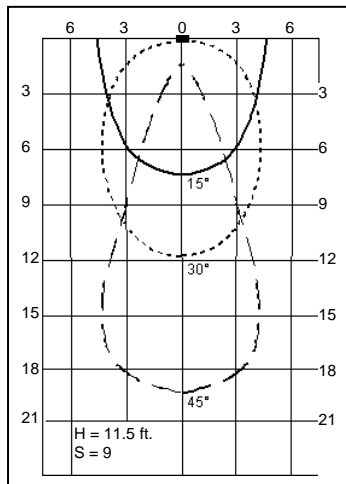

The sensing fields here on the right correspond to the following adjustments:

- tilt angle: 30°
- sensitivity: 9, 6, 3

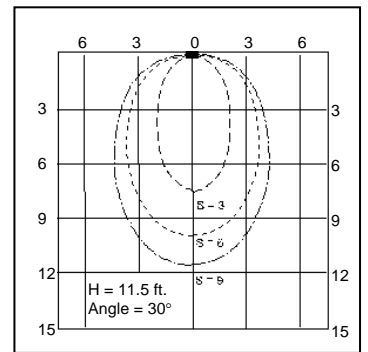

FALCON XL (Mounting height: 8 feet)

The sensing fields here on the right correspond to the following adjustments:

- tilt angle: 15°, 30°, 45° ;
- sensitivity: 9.

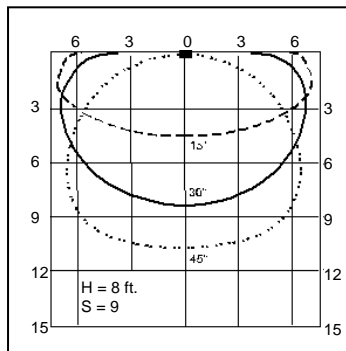

The sensing fields here on the right correspond to the following adjustments:

- tilt angle: 30°
- sensitivity: 9, 6, 3

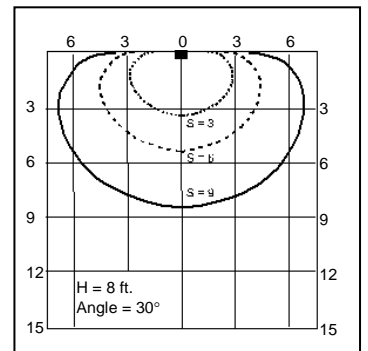

LED SIGNAL

- When the power is turned ON, the red and green LEDs flash for few seconds.
- During a detection the red LED lights on.
- During configuration, the red LED flashes a number of times corresponding to the parameter being changed (see next table). The green LED flashes a number corresponding to its setting.

1. DESCRIPTION OF THE INFRARED REMOTE CONTROL



- Open the battery compartment at the back of the remote control;
- Insert two AAA batteries supplied with the remote control as shown beside;
- Close the batteries compartment.

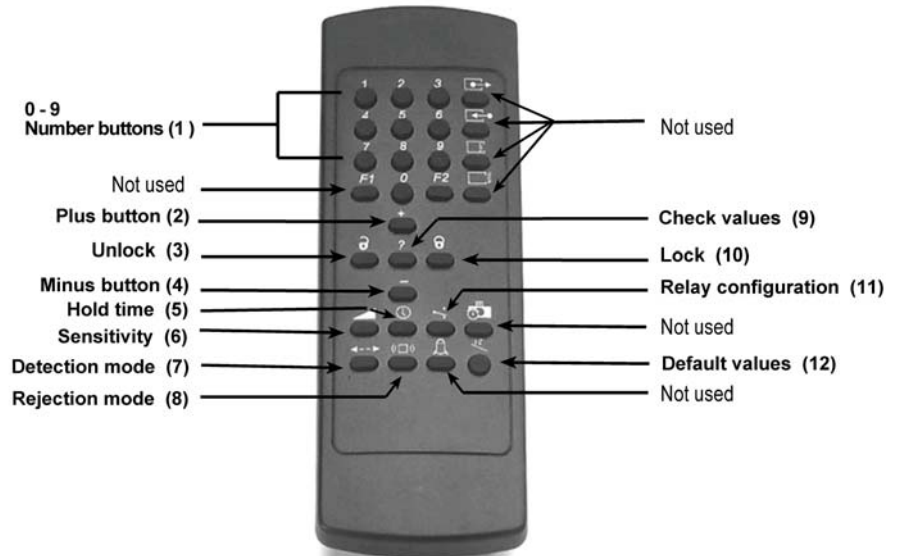

















Remark: For optimum results point the remote control at the sensor before pressing its buttons.













2. CONFIGURATION OF THE SENSOR

Each setting change using the infrared remote control must start with an unlocking and end with a locking of the sensor. It is important to point out that any parameters changed using the remote control supersede any previous setting.





The table below lists all the parameters, which can be adjusted with the remote control as well as the operations, required to adjust them.













































PARAMETER KEY	USER'S ACTIONS	FACTORY SETTING	LED SIGNAL
UNLOCK 	<p>Press the UNLOCK Key (3). Enter your four-digit access code using NUMBER Keys 0-9 (1).</p> <p>During the first sensor adjustment or if the access code is reset to the '0000' value (factory setting) or during the first minute after the power-on, press only the UNLOCK Key (3) (no code required).</p> <p><i>UNLOCK with code</i>     </p> <p><i>UNLOCK without code</i> </p>	0000	<p>The red LED flashes quickly waiting for the access code.</p> <p>After entering the correct code or if no code is required, the red LED flashes slowly to indicate that the unlock is successful and the adjustment session has begun.</p> <p>NOTE:  = Adjustment session ON</p>
LOCK 	<p>When all the parameters have been set, press the LOCK Key (10).</p> <p>If you wish to enter a new access code, use NUMBER Keys 0-9 (1) to enter the new four-figure code within 20 seconds.</p> <p>If no access code is entered or if you want to keep the current access code, press the LOCK Key (10) once more.</p> <p>If no remote control key is pressed within 1 minute, the adjustment session is automatically locked.</p> <p>Pressing the LOCK Key (10) twice within the first minute after the power-on reset automatically the access code to 0000 value.</p> <p><i>LOCK with code change</i>     </p> <p><i>LOCK without code or Code change</i>  </p>	0000	<p>The red LED stops flashing to return to its normal function.</p>





During an adjustment session each parameter may be checked or changed at any time in the following way:

PARAMETER KEY	USER'S ACTIONS
CHECK VALUES 	Press the Key (5,6,7,8,11) corresponding to the parameter to be checked and then press the CHECK VALUES Key (9) . Count the number of times the green LED flashes, which correspond to the value of the checked parameter. No green LED flash corresponds to the value 0. Repeat this operation to check the value of the other parameters if required. Example: SENSITIVITY Key (6) – 7 flashes of the green LED: the sensitivity is set at the value 7. <i>CHECK VALUES:</i>   
PLUS 	Press the Key (5 or 6) corresponding to the hold time or sensitivity parameter to be modified and then press the PLUS Key (2) to increase the value by 1 unit. <i>PLUS:</i>   
MINUS 	Press the Key (5 or 6) corresponding to the hold time or sensitivity parameter to be modified, and then press the MINUS Key (4) to reduce the value by 1 unit. <i>MINUS:</i>   

During a sensor adjustment session all the parameters may be reset to their factory values in the following way:

PARAMETER KEY	USER'S ACTIONS
DEFAULT VALUES 	Press the DEFAULT VALUES Key (12) , then press the NUMBER Key 1 . All the parameters are reset to the factory values (see below). <i>DEFAULTS VALUES:</i>   

PARAMETER KEY	USER'S ACTIONS	FACTORY SETTING	LED SIGNAL																					
SENSITIVITY 	Press the SENSITIVITY Key (6) . Use the NUMBER Keys 0-9 (1) to enter the sensitivity required (or adjust this sensitivity using the PLUS (2) or MINUS (4) keys as explained above) <i>SENSITIVITY:</i>   	7	The red LED flashes quickly waiting for the value. Once this has been entered, it flashes slowly again.																					
HOLD TIME 	Press the HOLD TIME Key (5) . Use the NUMBER Keys 0-9 (1) to enter the required hold time (0.5 s to 9 s) (or adjust this parameter using the PLUS (2) or MINUS (4) keys as explained above). <i>HOLD TIME:</i>   	0.5 s	The red LED flashes quickly waiting for the value. Once this has been entered, it flashes slowly again.																					
RELAY CONFIGURATION 	Press the RELAY CONFIGURATION Key (11) . Use the NUMBER Keys 1-4 (1) to select the required relay configuration: <table border="1" style="width: 100%; text-align: center;"> <thead> <tr> <th></th> <th>Active</th> <th>Passive</th> <th>+ 1</th> <th>+ 2</th> <th>+ 3</th> <th>+ 4</th> </tr> </thead> <tbody> <tr> <td>Detection</td> <td></td> <td></td> <td> + 1</td> <td> + 2</td> <td> + 3</td> <td> + 4</td> </tr> <tr> <td>No Detection</td> <td></td> <td></td> <td> + 1</td> <td> + 2</td> <td> + 3</td> <td> + 4</td> </tr> </tbody> </table>		Active	Passive	+ 1	+ 2	+ 3	+ 4	Detection			 + 1	 + 2	 + 3	 + 4	No Detection			 + 1	 + 2	 + 3	 + 4	1 (Active Output)	The red LED flashes quickly waiting for the value. Once this has been entered, it flashes slowly again.
	Active	Passive	+ 1	+ 2	+ 3	+ 4																		
Detection			 + 1	 + 2	 + 3	 + 4																		
No Detection			 + 1	 + 2	 + 3	 + 4																		

<p>DETECTION MODE</p> 	<p>Press the DETECTION MODE key (7). Use the NUMBER Keys 1-3 (1) to select the required mode: Key 1: bi-directional Key 2: unidirectional approach Key 3: unidirectional depart Detection mode:   </p>	<p>2 (Unidirectional Approach)</p>	<p>The red LED flashes quickly waiting for the value. Once this has been entered, it flashes slowly again.</p>																																
<p>REJECTION MODE</p> 	<p>Press the REJECTION MODE key (8). Immunity is used to avoid detection due to environmental interferences (vibrations, rains, etc). 'Pedestrian/parallel traffic rejection' provides both rejection of pedestrian and rejection of any parallel traffic at the same time.</p> <p>Use the NUMBER keys 1- 5 (1) to enter the required rejection mode: key 1 : detection of all kind of targets in motion key 2 : detection of all kind of targets in motion + interference immunity key 3 : Low 'Pedestrian/parallel traffic' rejection + interference immunity key 4 : Mid 'Pedestrian/parallel traffic' rejection + interference immunity key 5 : High 'Pedestrian/parallel traffic' rejection + interference immunity</p> <p>The discrimination between a pedestrian and the different vehicles depends mainly on the mounting height and the microwave module tilt angle. Be careful that the rejection function increases the response time of the sensor.</p> <p>Use the next table as suggestions and do not hesitate to increase or decrease the rejection level to obtain the required rejection.</p> <table border="1" data-bbox="462 1113 868 1470"> <thead> <tr> <th colspan="3" rowspan="2">Recommended key</th> <th colspan="3">Tilt angle</th> </tr> <tr> <th>15°</th> <th>30°</th> <th>45°</th> </tr> </thead> <tbody> <tr> <td rowspan="3">Mounting height</td> <td rowspan="3">FALCON</td> <td>23 ft</td> <td>3</td> <td>4</td> <td>4</td> </tr> <tr> <td>16.5 ft</td> <td>3</td> <td>4</td> <td>4</td> </tr> <tr> <td>11.5 ft</td> <td>4</td> <td>4</td> <td>5</td> </tr> <tr> <td rowspan="2">FALCON XL</td> <td>10 ft</td> <td>3</td> <td>4</td> <td>4</td> </tr> <tr> <td>7.5 ft</td> <td>4</td> <td>4</td> <td>5</td> </tr> </tbody> </table>	Recommended key			Tilt angle			15°	30°	45°	Mounting height	FALCON	23 ft	3	4	4	16.5 ft	3	4	4	11.5 ft	4	4	5	FALCON XL	10 ft	3	4	4	7.5 ft	4	4	5	<p>1 (No rejection)</p>	<p>The red LED flashes quickly waiting for the value. Once this has been entered, it flashes slowly again.</p>
Recommended key					Tilt angle																														
			15°	30°	45°																														
Mounting height	FALCON	23 ft	3	4	4																														
		16.5 ft	3	4	4																														
		11.5 ft	4	4	5																														
FALCON XL	10 ft	3	4	4																															
	7.5 ft	4	4	5																															

<p>FUNCTIONS CONFIGURATION WITH PUSH BUTTONS</p>	<p>Without remote control all of the parameters can be set using the 2 push buttons. NOTE: These two buttons are accessible from the sensor front cover with a small point.</p> <ul style="list-style-type: none"> To adjust the sensor using the buttons: Press and hold either push button for 2 seconds (until the LEDs flash) and then release the button To end adjusting the sensor using the buttons: Press and hold either push button for 2 seconds (until the LEDs stop flashing) and then release the button; NOTE: If no button is pressed within 20 seconds the adjustment session is automatically ended. To reset all the parameters to the factory values: Press and hold both push buttons simultaneously until the two LEDs switch on for 1 second (after 2 seconds). <p>During the manual adjustment session the red and green LEDs flash successively and continuously.</p> <ul style="list-style-type: none"> The flashing number of the red LED provides the number of the displayed parameter (see next table); The flashing number of the green LED provides the value of the displayed parameter; <p>NOTE: No red flashing indicates the zero value.</p>
---	---

During the manual adjustment session:

- Each press on the **right button** increases the number of the displayed parameter by one unit;
 - Each press on the **left button** increases the value of the displayed parameter by one unit.
- NOTE:** When the maximum value or the highest number of the parameter is reached, this will return to their minimum values.

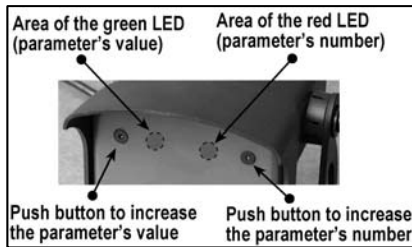

Parameter Number	Parameter	Values	Factory setting
1	Sensitivity	0 - 9	7
2	Hold time	0 - 9	0
3	Relay configuration	1 - 4	1
4	Detection mode	1 - 3	2
5	Pedestrian rejection mode	1 - 5	1

For example, to change the sensitivity from 7 to 9 and the rejection mode from 'detection of all kind of targets in motion' to High 'Pedestrian/parallel traffic' rejection.

- Press any button for 2 seconds to enter the adjustment session and then release it.
- The red LED flashes once (parameter 1 = sensitivity) and the green LED flashes 7 times (sensitivity=7).
- Press the left button twice to increase the sensitivity from 7 to 9.
- The red LED still flashes once (parameter 1 = sensitivity) but the green LED flashes 9 times now (sensitivity=9).
- Now press the right button 4 times to move to function 5 (rejection mode) ;
- The red LED flashes 5 times (parameter 5 = rejection mode) and the green LED flashes once ('detection of all kind of targets in motion') ;
- Press the left button 4 times to set the parameter to High 'Pedestrian/parallel traffic' rejection.
- The red LED still flashes 5 times (parameter 5 = rejection mode) but the green LED flashes 5 times now (High 'Pedestrian/parallel traffic' rejection).
- Press any button during 2 seconds to end the adjustment session and then release it.

TROUBLE-SHOOTING

<i>SYMPTOM</i>	<i>PROBABLE CAUSE</i>	<i>CORRECTIVE ACTION</i>
The door will not open and the red LED does not light up.	The sensor power is off.	Check power supply. Check the supply voltage.
The door opens and closes constantly.	The sensor 'sees' the door moving.	Increase the tilt angle and/or reduce the sensitivity.
	When closing the door creates vibrations picked up by the sensor.	Ensure that the sensor is correctly fixed. If the rejection mode is set at level 1, set this parameter to level 2. Reduce the sensitivity. Switch to unidirectional mode.
The door opens and closes after a given time for no apparent reason.	The sensor is picking up unintended traffic motion.	Reduce the sensitivity. Reduce the tilt angle.
The sensor is not capable of activation near the door.	The tilt angle is too large.	Reduce the tilt angle.
The sensor does not respond to the remote control.	The batteries are weak.	Check the batteries insertion. Change the batteries.
	The access code has been changed.	<ul style="list-style-type: none"> • Press both push buttons simultaneously to reset all the parameters to the factory values. • Or switch off the power supply. Within the first minute after the power on, change the access code.

**For more information, please visit www.devancocanada.com
or call toll free at 855-931-3334**

***HOW TO ORDER
REPAIR PARTS***

DEVANCO CANADA

19192 HAY ROAD, UNIT Q
SUMMERSTOWN, ON K0C 2E0

TOLL FREE: 855-931-3334

www.devancocanada.com

**WHEN ORDERING REPAIR PARTS
PLEASE SUPPLY THE
FOLLOWING INFORMATION:**

- ✓ PART NUMBER
- ✓ DESCRIPTION
- ✓ MODEL NUMBER