

CHAMBERLAIN®
ELITE™

OWNER'S MANUAL

CSW200UL™
VEHICULAR SWING GATE OPERATOR



THE CSW200UL™ IS FOR USE ON VEHICULAR PASSAGE GATES ONLY
AND NOT INTENDED FOR USE ON PEDESTRIAN PASSAGE GATES.

INTENDED FOR PROFESSIONAL INSTALLATION ONLY.

UL325 UL991
compliant compliant



TABLE OF CONTENTS

! WARNING

Mechanical

⚡ WARNING

Electrical

CAUTION

When you see these Safety Symbols and Signal Words on the following pages, they will alert you to the possibility of **SERIOUS INJURY** or **DEATH** if you do not comply with the warnings that accompany them. The hazard may come from something mechanical or from electric shock. Read the warnings carefully.

When you see this Signal Word on the following pages, it will alert you to the possibility of damage to your gate and/or the gate operator if you do not comply with the cautionary statements that accompany it. Read them carefully.

IMPORTANT NOTE

- **BEFORE** attempting to install, operate or maintain the operator, you must read and fully understand this manual and follow all safety instructions.
- **DO NOT** attempt repair or service of your gate operator unless you are an Authorized Service Technician.

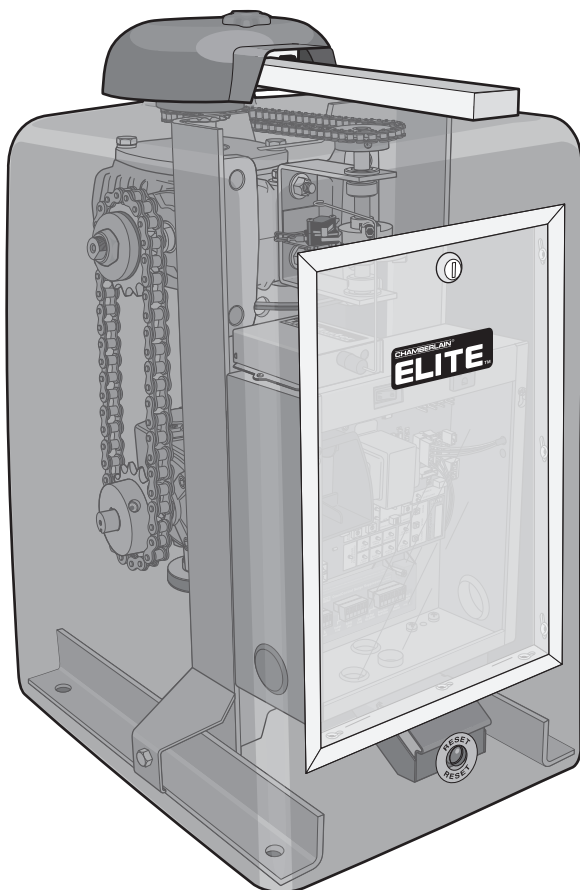

SPECIFICATIONS AND WARNINGS

Overview and Specifications	2
Model Classification	3
Safety Installation Information	4
Gate Construction Information	5
Suggested Entrapment Protection Device Locations	6-7
Safety Precautions	8

INSTALLATION

Installation Setups	9
Concrete Pad and Arm Attachment.	10
Standard Installation Layout	11
Compact Installation Layout	12
Uphill Driveway Post Mounting Plate Installation	13
Gate Arm Installation	14
Output Shaft Adjustment	14
Control Board Description	15
Surge Suppressor Terminal Connections	16

WIRING

Earth Ground Rod Installation	17
110Vac Power Connection	18
Heater Power Connection	18
Linking Master/Second Operators	19
Solenoid/Maglock Connections.	20
DC2000 Back-Up Connections	21-22
Plug-In Loop Detector Wiring	23
110Vac External Loop Detector Wiring.	24
Entrapment Protection Devices (Edge Sensors)	25
Entrapment Protection Devices (Non-Contact Sensors)	26

ADJUSTMENTS

Set Gate Opening Direction.	27
Limit Switch Adjustments.	28
Clutch Adjustment	28
Radio Receiver Programming	29-30
Setting the Timer (On, Off)	31
Adjusting Reversing Sensor(s)	32
OmniControl™ Board Connections	33

MAINTENANCE AND OPERATION

Maintenance	34
-----------------------	----

OPERATION

Built-In Reset Switch	35
Audio Alarm	35

EMERGENCY MANUAL RELEASE

37-42

TROUBLESHOOTING

43-44

REPAIR PARTS

45-46

ACCESSORIES

47

INSTALLATION CHECKLIST

51

WARRANTY POLICY

52

Specifications and Warnings

CSW200UL™ MODELS OVERVIEW

Single Motor and Stainless Models

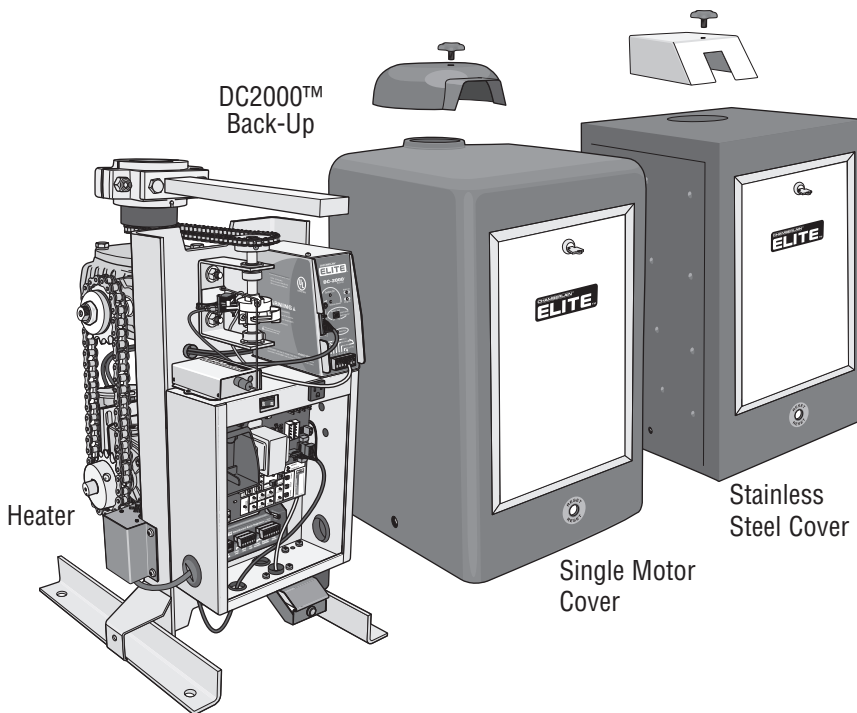

All operators come with 2 warning placards and a warranty card.



CSW200UL™ (Single Motor)

1/2 HP Motor, 120Vac, 4 Amp.
Maximum Gate Length – 20 ft. Maximum Gate Weight – 600 lbs.
Maximum Pull – 125 lbs.

CSW200ULDC™ (Single Motor)

1/2 HP Motor, DC2000™, 120Vac, 4 Amp.
Maximum Gate Length – 20 ft. Maximum Gate Weight – 600 lbs.
Maximum Pull – 125 lbs.

CSW200ULH™ (Single Motor)

1/2 HP Motor, 120Vac, 4 Amp., Heater 3 Amp
Maximum Gate Length – 20 ft. Maximum Gate Weight – 600 lbs.
Maximum Pull – 125 lbs.

CSW200ULDCH™ (Single Motor)

1/2 HP Motor, DC2000™, 120Vac, 4 Amp., Heater 3 Amp
Maximum Gate Length – 20 ft. Maximum Gate Weight – 600 lbs.
Maximum Pull – 125 lbs.

CSW200ULST™ (Stainless Steel Cover)

1/2 HP Motor, 120Vac, 4 Amp.
Maximum Gate Length – 20 ft. Maximum Gate Weight – 600 lbs.
Maximum Pull – 125 lbs.

CSW200ULSTDC™ (Stainless Steel Cover)

1/2 HP Motor, DC2000™, 120Vac, 4 Amp.
Maximum Gate Length – 20 ft. Maximum Gate Weight – 600 lbs.
Maximum Pull – 125 lbs.

CSW200ULSTH™ (Stainless Steel Cover)

1/2 HP Motor, 120Vac, 4 Amp., Heater 3 Amp
Maximum Gate Length – 20 ft. Maximum Gate Weight – 600 lbs.
Maximum Pull – 125 lbs.

CSW200ULSTDCH™ (Stainless Steel Cover)

1/2 HP Motor, DC2000™, 120Vac, 4 Amp., Heater 3 Amp
Maximum Gate Length – 20 ft. Maximum Gate Weight – 600 lbs.
Maximum Pull – 125 lbs.

Dual Motor and 1 HP Models

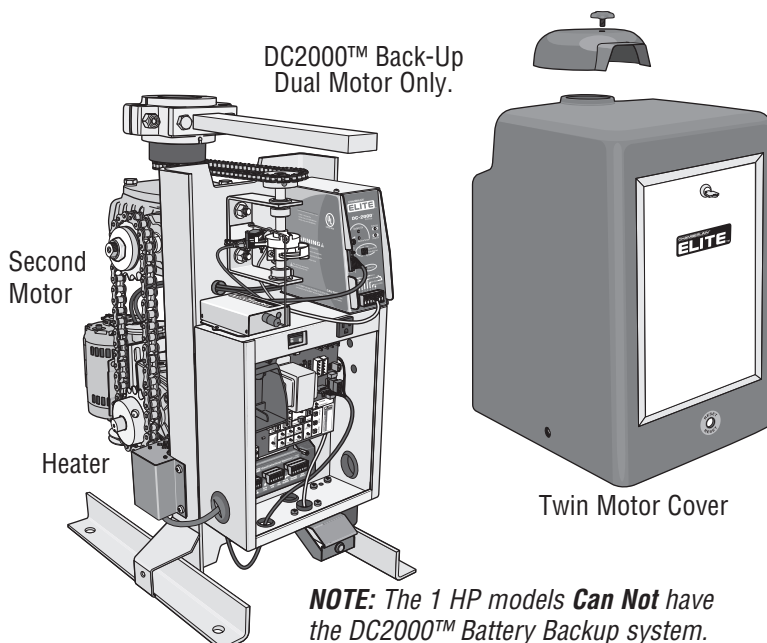

NOTE: The 1 HP models **Can Not** have the DC2000™ Battery Backup system.

CSW200ULDM™ (Dual Motor)

Two-1/2 HP Motors, 120Vac, 4 Amp.
Maximum Gate Length – 20 ft. Maximum Gate Weight – 800 lbs.
Maximum Pull – 115 lbs.

CSW200ULDMDC™ (Dual Motor)

Two-1/2 HP Motors, DC2000™, 120Vac, 4 Amp.
Maximum Gate Length – 20 ft. Maximum Gate Weight – 800 lbs.
Maximum Pull – 115 lbs.

CSW200ULDMH™ (Dual Motor)

Two-1/2 HP Motors, 120Vac, 4 Amp., Heater 3 Amp
Maximum Gate Length – 20 ft. Maximum Gate Weight – 800 lbs.
Maximum Pull – 115 lbs.

CSW200ULDMDCH™ (Dual Motor)

Two-1/2 HP Motors, DC2000™, 120Vac, 4 Amp., Heater 3 Amp
Maximum Gate Length – 20 ft. Maximum Gate Weight – 800 lbs.
Maximum Pull – 115 lbs.

CSW200UL1HP™ (1 Horse Power)

Two-1/2 HP Motors, 120Vac, 7.9 Amp.
Maximum Gate Length – 22 ft. Maximum Gate Weight – 1000 lbs.
Maximum Pull – 250 lbs.

CSW200UL1HPH™ (1 Horse Power)

Two-1/2 HP Motors, 120Vac, 7.9 Amp., Heater 3 Amp
Maximum Gate Length – 22 ft. Maximum Gate Weight – 1000 lbs.
Maximum Pull – 250 lbs.

UL325 MODEL CLASSIFICATIONS

The CSW200UL™ is intended for use in vehicular swing gate applications:

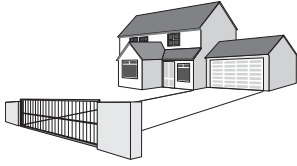

Class I – Residential vehicular gate operator

A vehicular gate operator (or system) intended for use in a home of one-to four single family dwellings, or a garage or parking area associated therewith.

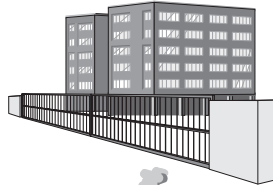

Class II – Commercial/General access vehicular gate operator

A vehicular gate operator (or system) intended for use in a commercial location or building such as a multi-family housing unit (five or more single family units) hotel, garage, retail store or other building servicing the general public.

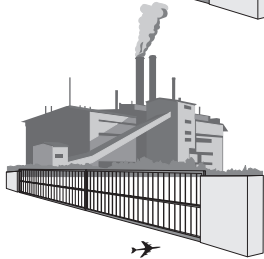

Class III – Industrial/Limited access vehicular gate operator

A vehicular gate operator (or system) intended for use in an industrial location or building such as a factory or loading dock area or other location not intended to service the general public.

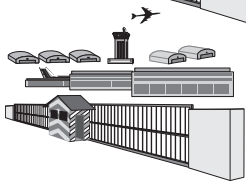

Class IV – Restricted access vehicular gate operator

A vehicular gate operator (or system) intended for use in a guarded industrial location or building such as an airport security area or other restricted access locations not servicing the general public, in which unauthorized access is prevented via supervision by security personnel.

UL325 ENTRAPMENT PROTECTION REQUIREMENTS

This chart illustrates the entrapment protection requirements for each of the four UL325 classes.

GATE OPERATOR ENTRAPMENT PROTECTION

UL325 Installation Classification	Slide Gate Operator		Swing & Gate Barrier (Arm) Operator	
	Primary Type	Secondary Type	Primary Type	Secondary Type
Class I Class II	A	B1, B2 or D	A or C	A, B1, C, or D, B2
Class III	A, B1, B2 or B2	A, B1, D or E	A, B1, C or C	D or E
Class IV	A, B1, B2 or D	A, B1, B2, D or E	A, B1, C or D	A, B1, C, D or E

In order to complete a proper installation you must satisfy the entrapment protection chart shown. That means that the installation must have one *primary* means of entrapment protection and one independent *secondary* means of entrapment protection. Both primary and secondary entrapment protection methods must be designed, arranged or configured to protect against entrapments in both the open and close directions of gate travel.

For Example: For a gate system that is installed on a single-family residence (UL325 Class I) you must provide the following: As your *primary type* of entrapment protection you must provide

- **Type A** - Inherent (built into the operator) entrapment sensing and at least one of the following as your *secondary entrapment protection*:
- **Type B1** - Non-contact sensors such as photoelectric sensors,
- **Type B2** - Contact sensors such as edge sensors or
- **Type D** - Constant pressure control.
- **Type E** - Built-in audio alarm.

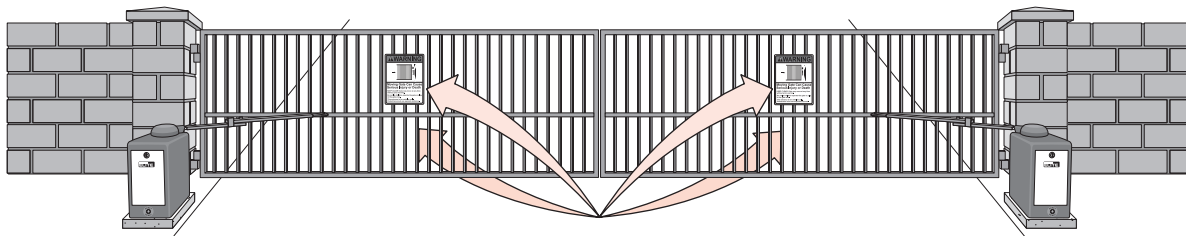

NOTE: UL requires that all installations must have warning placards placed in plain view on both sides of the gate to warn pedestrians of the dangers of motorized gate systems.

SAFETY INSTALLATION INFORMATION

1. Vehicular gate systems provide convenience and security. Gate systems are comprised of many component parts. The gate operator is only one component. Each gate system is specifically designed for an individual application.
2. Gate operating system designers, installers and users must take into account the possible hazards associated with each individual application. Improperly designed, installed or maintained systems can create risks for the user as well as the bystander. Gate systems design and installation must reduce public exposure to potential hazards.
3. A gate operator can create high levels of force in its function as a component part of a gate system. Therefore, safety features must be incorporated into every design. Specific safety features include:
 - Gate Edges
 - Guards for Exposed Rollers
 - Photoelectric Sensors
 - Screen Mesh
 - Vertical Posts
 - Instructional and Precautionary Signage
4. Install the gate operator only when:
 - a. The operator is appropriate for the construction and the usage class of the gate.
 - b. All openings of a horizontal swing gate are guarded or screened from the bottom of the gate to a minimum of 4 feet (1.2 m) above the ground to prevent a 2 1/4 inches (6 cm) diameter sphere from passing through the openings anywhere in the gate, and in that portion of the adjacent fence that the gate covers in the open position.
 - c. All exposed pinch points are eliminated or guarded, and guarding is supplied for exposed rollers.
5. The operator is intended for installation only on gates used for vehicles. Pedestrians must be supplied with a separate access opening. The pedestrian access opening shall be designed to promote pedestrian usage. Locate the gate such that persons will not come in contact with the vehicular gate during the entire path of travel of the vehicular gate.
6. The gate must be installed in a location so that enough clearance is supplied between the gate and adjacent structures when opening and closing to reduce the risk of entrapment. Swinging gates shall not open into public access areas.
7. The gate must be properly installed and work freely in both directions prior to the installation of the gate operator.
8. Controls intended for user activation must be located at least six feet (6') away from any moving part of the gate and where the user is prevented from reaching over, under, around or through the gate to operate the controls. Outdoor or easily accessible controls shall have a security feature to prevent unauthorized use.
9. The Stop and/or Reset (if provided separately) must be located in the line-of-sight of the gate. Activation of the reset control shall not cause the operator to start.
10. A minimum of two (2) WARNING PLACARDS shall be installed, one on each side of the gate where easily visible.
11. For a gate operator utilizing a non-contact sensor:
 - a. Reference owner's manual regarding placement of non-contact sensor for each type of application.
 - b. Care shall be exercised to reduce the risk of nuisance tripping, such as when a vehicle trips the sensor while the gate is still moving.
 - c. One or more non-contact sensors shall be located where the risk of entrapment or obstruction exists, such as the perimeter reachable by a moving gate or barrier.
12. For a gate operator utilizing a contact sensor such as an edge sensor:
 - a. One or more contact sensors shall be located where the risk of entrapment or obstruction exists, such as at the leading edge, trailing edge and post mounted both inside and outside of a vehicular horizontal slide gate.
 - b. One or more contact sensors shall be located at the bottom edge of a vehicular vertical lift gate.
 - c. A hard wired contact sensor shall be located and its wiring arranged so the communication between the sensor and the gate operator is not subject to mechanical damage.
 - d. A wireless contact sensor such as the one that transmits radio frequency (RF) signals to the gate operator for entrapment protection functions shall be located where the transmission of the signals are not obstructed or impeded by building structures, natural landscaping or similar obstruction. A wireless contact sensor shall function under the intended end-use conditions.
 - e. One or more contact sensors shall be located on the inside and outside leading edge of a swing gate. Additionally, if the bottom edge of a swing gate is greater than 6 inches (152 mm) above the ground at any point in its arc of travel, one or more contact sensors shall be located on the bottom edge.
 - f. One or more contact sensors shall be located at the bottom edge of a vertical barrier (arm).

GATE CONSTRUCTION INFORMATION

Vehicular gates should be installed in accordance with ASTM F2200: Standard Specification for Automated Vehicular Gate Construction. For a copy, contact ASTM directly at 610-832-9585 or www.astm.org.

1. General Requirements

- 1.1 Gates shall be constructed in accordance with the provisions given for the appropriate gate type listed, refer to ASTM F2200 for additional gate types.
- 1.2 Gates shall be designed, constructed and installed to not fall over more than 45 degrees from the vertical plane, when a gate is detached from the supporting hardware.
- 1.3 Gates shall have smooth bottom edges, with vertical bottom edged protrusions not exceeding 0.50 inches (12.7 mm) when other than the exceptions listed in ASTM F2200.
- 1.4 The minimum height for barbed tape shall not be less than 8 feet (2.44 m) above grade and for barbed wire shall not be less than 6 feet (1.83 m) above grade.
- 1.5 An existing gate latch shall be disabled when a manually operated gate is retrofitted with a powered gate operator.
- 1.6 A gate latch shall not be installed on an automatically operated gate.
- 1.7 Protrusions shall not be permitted on any gate, refer to ASTM F2200 for exceptions.
- 1.8 Gates shall be designed, constructed and installed such that their movement shall not be initiated by gravity when an automatic operator is disconnected.
- 1.9 A pedestrian gate shall not be incorporated into a vehicular gate panel or that portion of the adjacent fence that the gate covers in the open position.

2. Specific Applications

2. Any non-automated gate that is to be automated shall be upgraded to conform to the provisions of this specification.
- 2.2 This specification shall not apply to gates generally used for pedestrian access and to vehicular gates not to be automated.
- 2.3 Any existing automated gate, when the operator requires replacement, shall be upgraded to conform to the provisions of this specification in effect at that time.

3. Vehicular Horizontal Slide Gates

- 3.1 The following provisions shall apply to Class I, Class II and Class III vehicular horizontal slide gates:
 - 3.1.1 All weight bearing exposed rollers 8 feet (2.44 m), or less, above grade shall be guarded or covered.
 - 3.1.2 All openings located between 48 inches (1.22 m) and 72 inches (1.83 m) above grade shall be designed, guarded or screened to prevent a 4 inch (102 mm) diameter sphere from passing through the openings anywhere in the gate, and in that portion of the adjacent fence that covers in the open position.
 - 3.1.3 A gap, measured in the horizontal plane parallel to the roadway, between a fixed stationary object nearest the roadway, (such as a gate support post) and the gate frame when the gate is in either the fully open position or the fully closed position, shall not exceed 2-1/4 inches (57 mm), refer to ASTM F2200 for exception.

- 3.1.4 Positive stops shall be required to limit travel to the designed fully open and fully closed positions. These stops shall be installed at either the top of the gate, or at the bottom of the gate where such stops shall horizontally or vertically project no more than is required to perform their intended function.
 - 3.1. All gates shall be designed with sufficient lateral stability to assure that the gate will enter a receiver guide, refer to ASTM F2200 for panel types.
 - 3.2 The following provisions shall apply to Class IV vehicular horizontal slide gates:
 - 3.2.1 All weight bearing exposed rollers 8 feet (2.44 m), or less, above grade shall be guarded or covered.
 - 3.2.2 Positive stops shall be required to limit travel to the designed fully open and fully closed positions. These stops shall be installed at either the top of the gate, or at the bottom of the gate where such stops shall horizontally or vertically project no more than is required to perform their intended function.

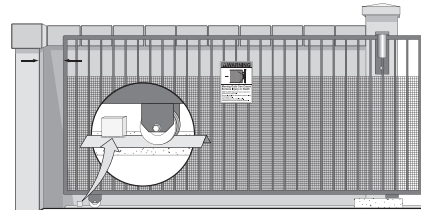

4. Vehicular Horizontal Swing Gates

- 4.1 The following provisions shall apply to Class 1, Class II and Class III vehicular horizontal swing gates:
 - 4.1.1 Gates shall be designed, constructed and installed so as not to create an entrapment area between the gate and the supporting structure or other fixed object when the gate moves toward the fully open position, subject to the provisions in the 4.1.1.1 and 4.1.1.2.
 - 4.1.1.1 The width of an object (such as a wall, pillar or column) covered by a swing gate when in the open position shall not exceed 4 inches (102 mm), measured from the centerline of the pivot point of the gate, refer to ASTM F2200 for exception.
 - 4.1.1.2 Except for the zone specified in Section 4.1.1.1, the distance between a fixed object such as a wall, pillar or column, and a swing gate when in the open position shall not be less than 16 inches (406 mm), refer to ASTM F2200 for exception.
 - 4.2 Class IV vehicular horizontal swing gates shall be designed, constructed and installed in accordance with security related parameters specific to the application in question.

SUGGESTED ENTRAPMENT PROTECTION DEVICE LOCATIONS

⚠️ WARNING

To prevent SERIOUS INJURY or DEATH from a moving gate:

- Entrapment protection devices **MUST** be installed to protect anyone who may come near a moving gate.
- Locate entrapment protection devices to protect in **BOTH** the open and close gate cycles.
- Locate entrapment protection devices to protect between moving gate and **RIGID** objects, such as posts or walls.
- A swinging gate shall **NOT** open into public access ways.

Non-Contact Sensors (Photoelectric Sensors)

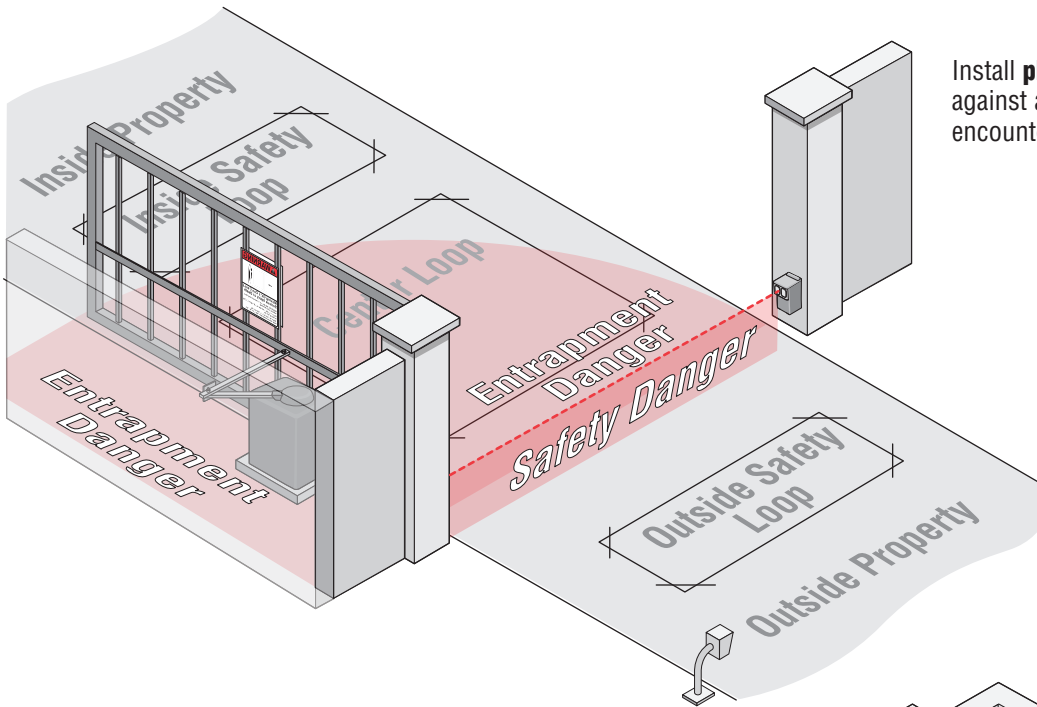

Safety loops allows the gate to stay open when vehicles are obstructing the gate path. Suggested for vehicles 14 feet or longer. If a vehicle is shorter, a center loop is recommended and should be installed.

A **center loop** protects during a **Close** cycle of the gate. Safety loops are required when using a center loop.

See Loop Wiring.

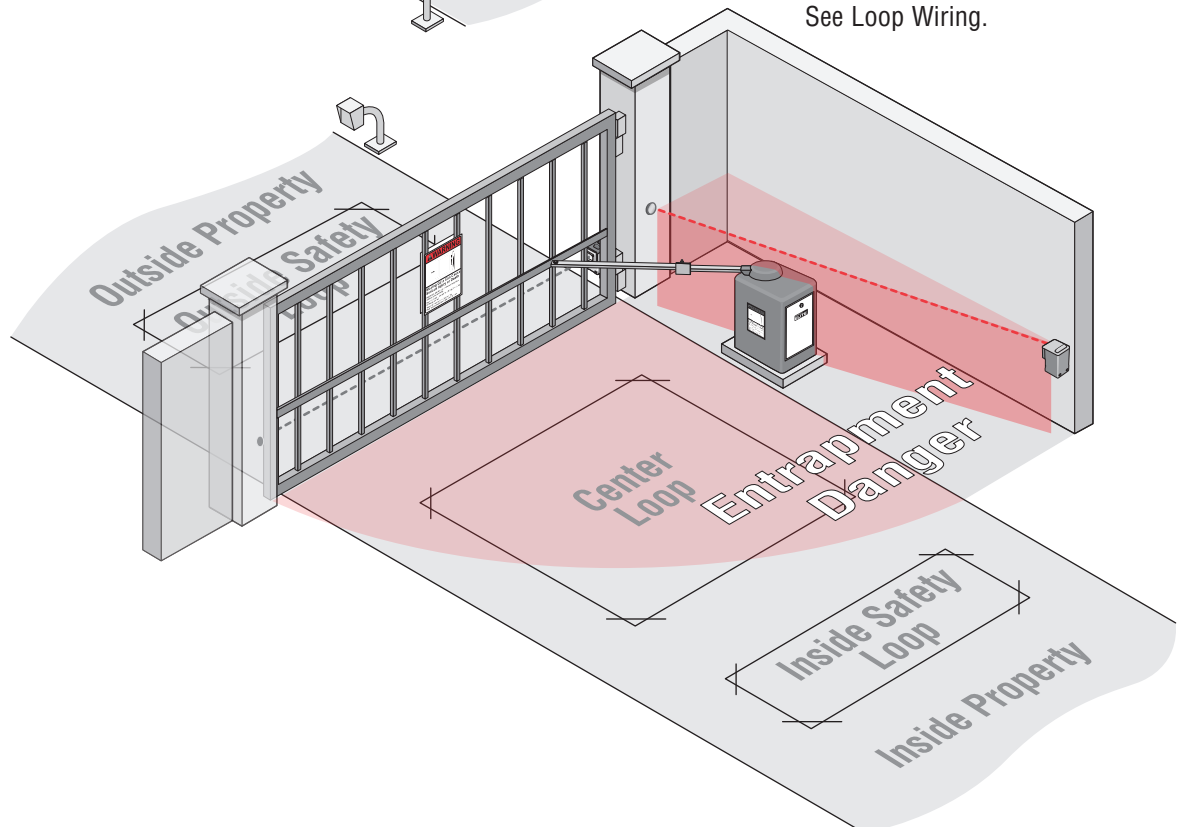

SUGGESTED ENTRAPMENT PROTECTION DEVICE LOCATIONS

⚠️ WARNING

To prevent SERIOUS INJURY or DEATH from a moving gate:

- Entrapment protection devices **MUST** be installed to protect anyone who may come near a moving gate.
- Locate entrapment protection devices to protect in **BOTH** the open and close gate cycles.
- Locate entrapment protection devices to protect between moving gate and **RIGID** objects, such as posts or walls.
- A swinging gate shall **NOT** open into public access ways.

Contact Sensors (Edge Sensors)

Install **edge sensors** to protect against any entrapment or safety conditions encountered in your gate application.

See Entrapment Protection Devices.

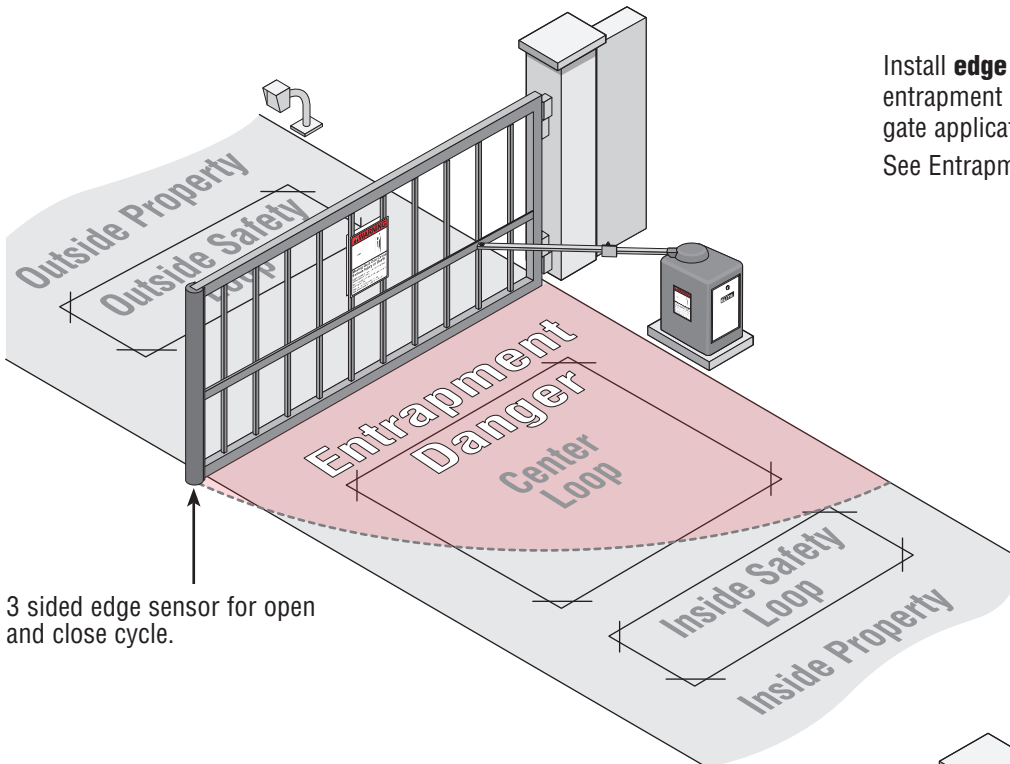

3 sided edge sensor for open and close cycle.

Safety loops allows the gate to stay open when vehicles are obstructing the gate path. Suggested for vehicles 14 feet or longer. If a vehicle is shorter, a center loop is recommended and should be installed.

A **center loop** protects during the **Close** cycle of a gate. Safety loops are required when using a center loop.

See Loop Wiring.

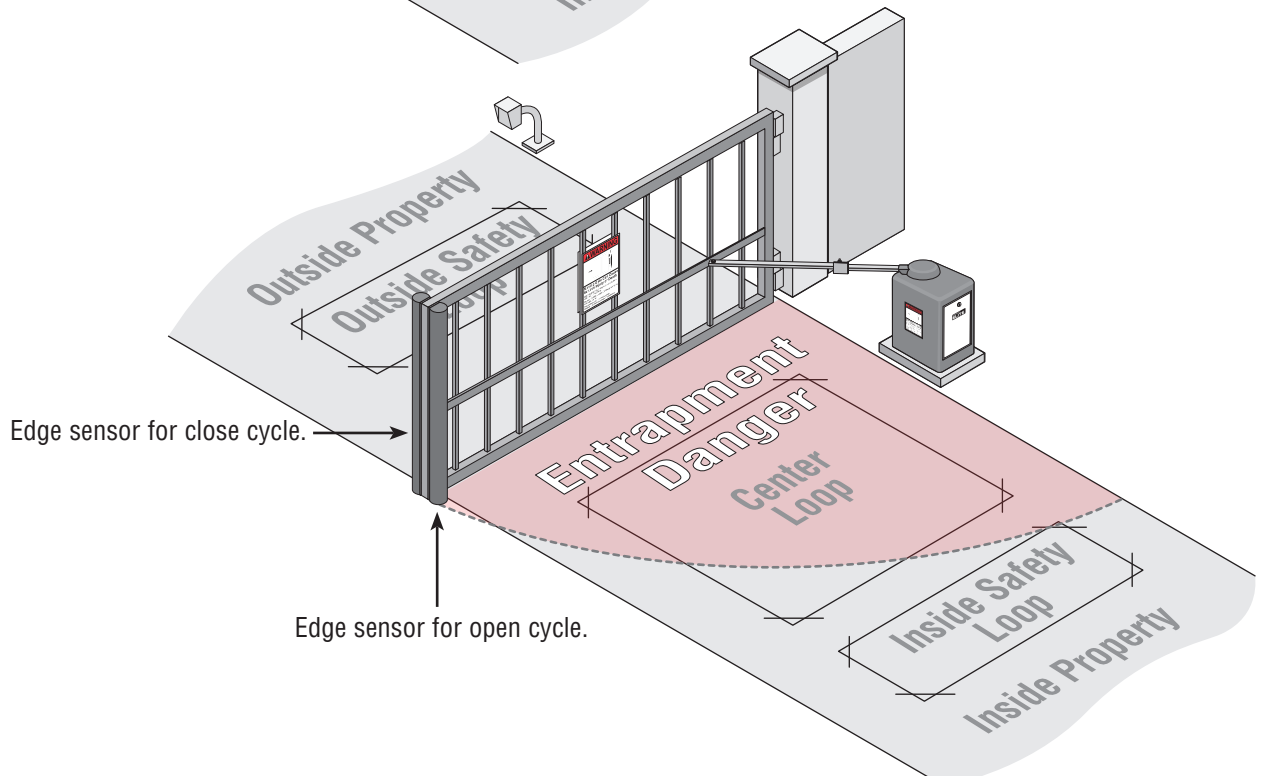

Edge sensor for close cycle.

Edge sensor for open cycle.

SAFETY PRECAUTIONS

THE CSW200UL™ IS FOR USE ON VEHICULAR PASSAGE GATES ONLY AND NOT INTENDED FOR USE ON PEDESTRIAN PASSAGE GATES.



Property owners MUST never mount any gate operating device near the gate's path!

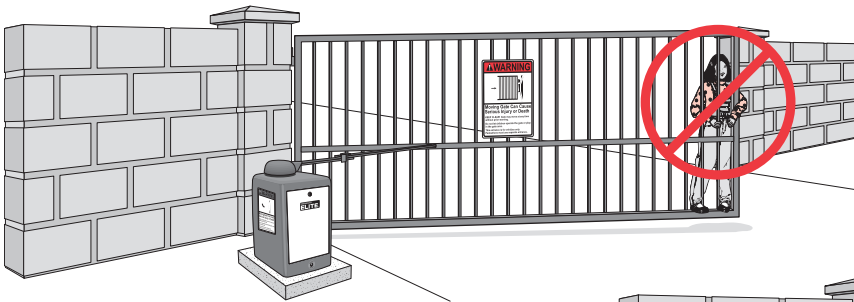

Property owners MUST never allow anyone to hang or ride on the gate!

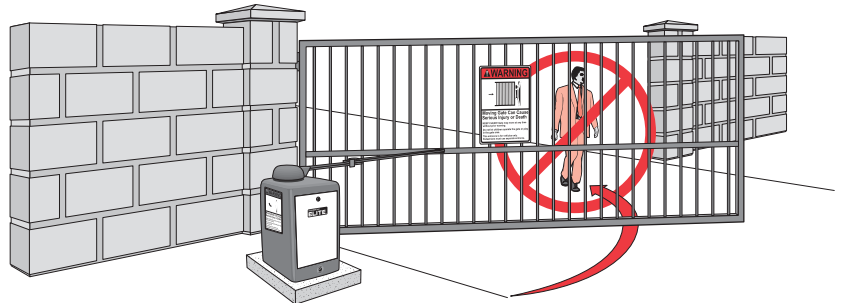

Property owners MUST never let pedestrians cross the path of a moving gate!

⚠️ WARNING

- To prevent SERIOUS INJURY or DEATH from a moving gate:
- Entrapment protection devices **MUST** be installed to protect anyone who may come near a moving gate.
 - Locate entrapment protection devices to protect in **BOTH** the open and close gate cycles.
 - Locate entrapment protection devices to protect between moving gate and **RIGID** objects, such as posts.
 - A swinging gate shall **NOT** open into public access ways.

WARNING PLACARD PLACEMENT

⚠️ WARNING

To prevent SERIOUS INJURY or DEATH from a moving gate:
Install warning placards on **BOTH** sides of **EACH** gate in **PLAIN VIEW**.

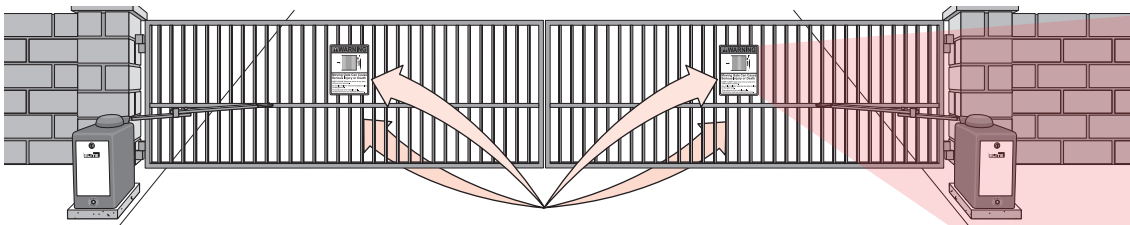

Installation

INSTALLATION SETUPS

Single Operator

Maximum gate length 20 ft. (22 ft. for 1HP)

Maximum gate weight is 600 lbs. (800 lbs. for DM) (1000 lbs. 1HP)

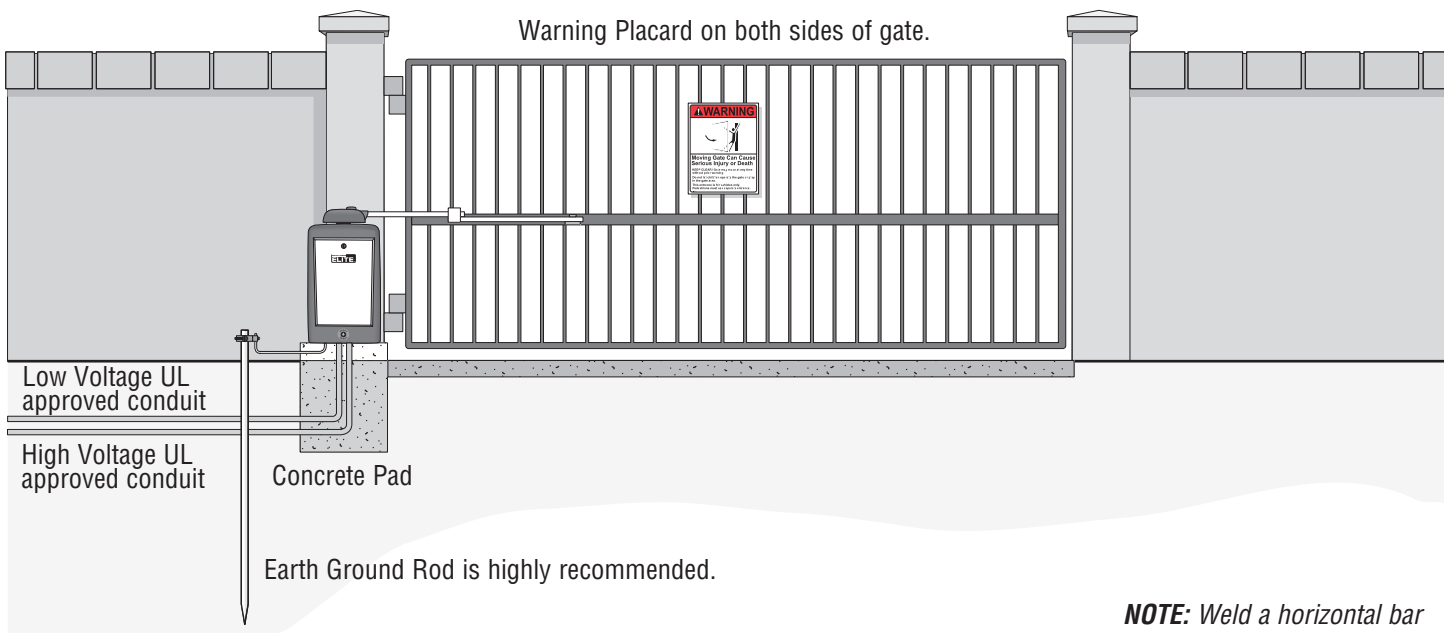

NOTE: Weld a horizontal bar across entire gate on any installation for strength.

Master/Second Operators

Maximum gate length 20 ft. (22 ft. for 1HP)

Maximum gate weight is 600 lbs. (800 lbs. for DM) (1000 lbs. 1HP)

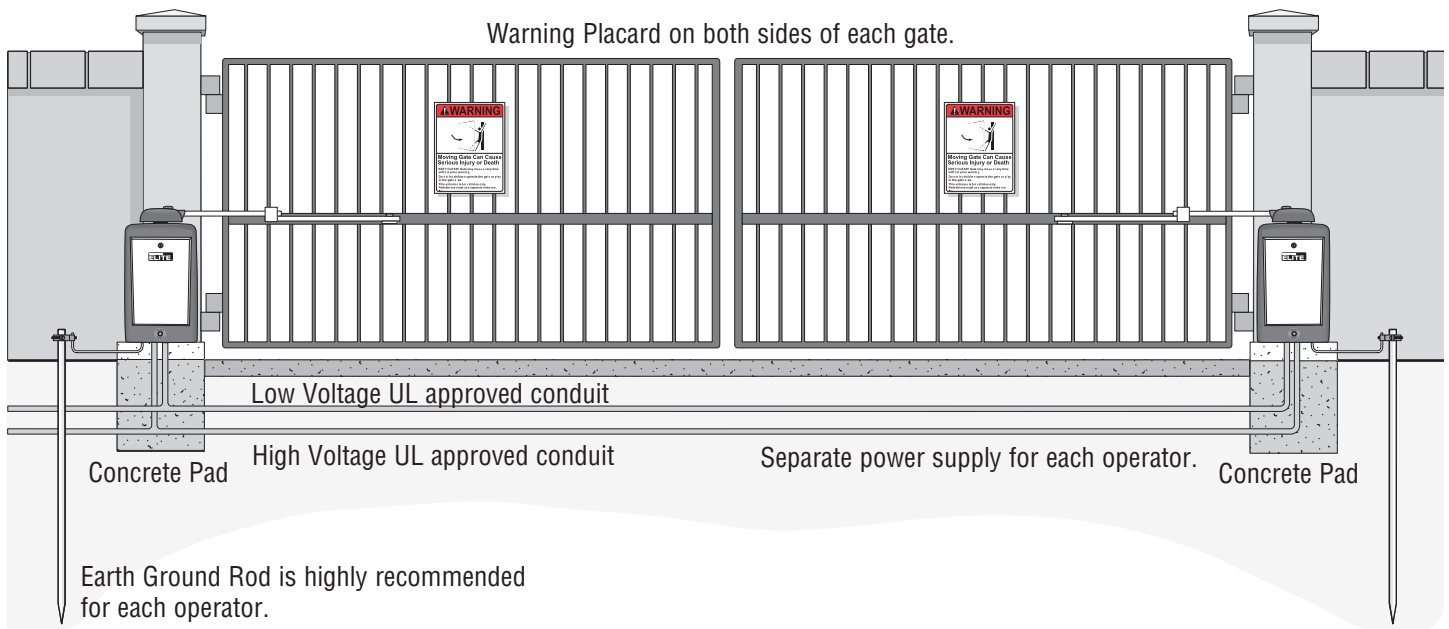

CONCRETE PAD AND ARM ATTACHMENT

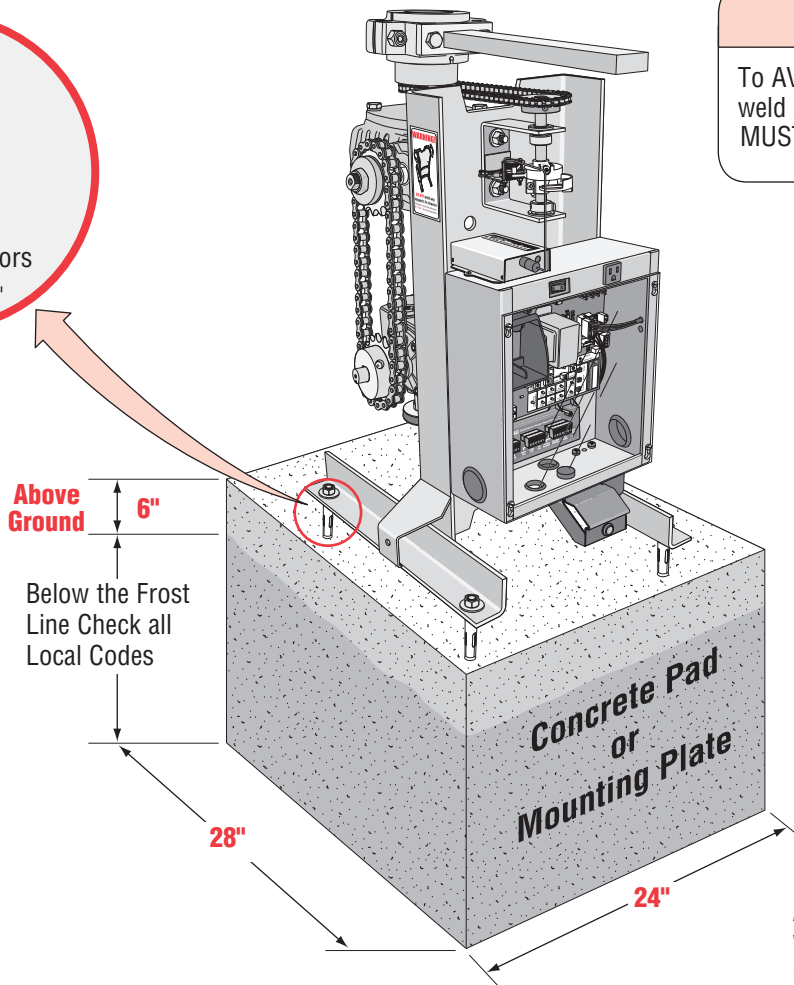
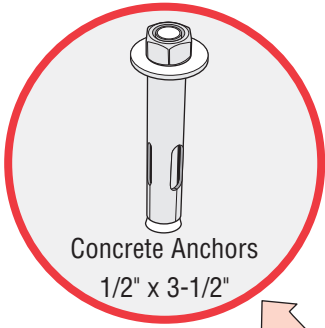

CAUTION

To AVOID damaging operator, DO NOT weld ANY supports to chassis. Chassis MUST be allowed to flex during operation.

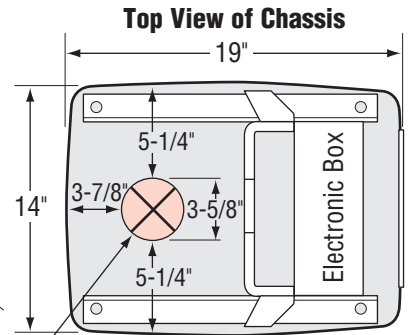

Approximate placement of high voltage and/or low voltage conduits.

Sample of Standard Arm Attachment (See next page for layout)

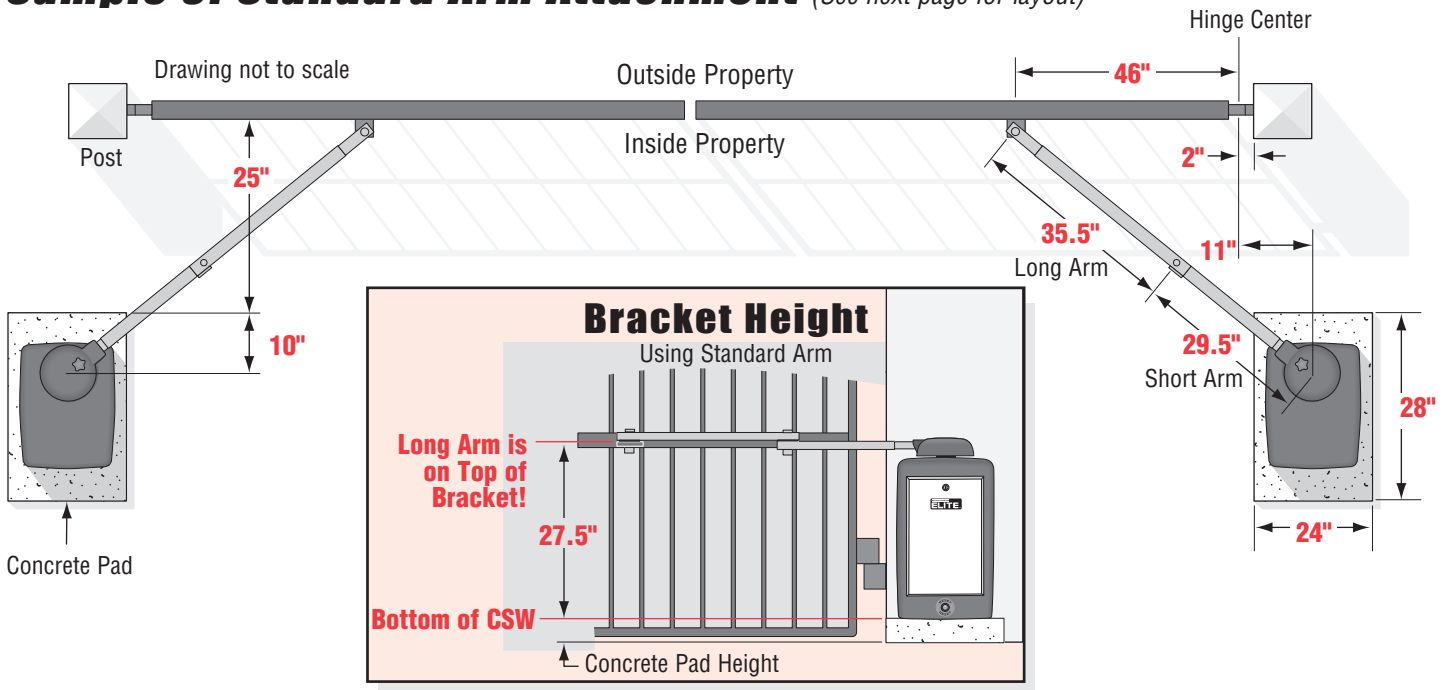

STANDARD INSTALLATION LAYOUT

Sample of standard arm attachment is shown on previous page.

Top View of Closed Gate

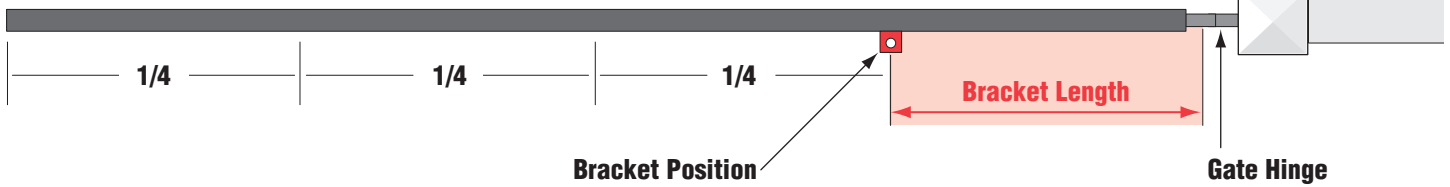

Mount bracket *at least* a quarter of the gate length from the gate hinge.

NOTE: Longer gates or retro-fits may require both arms to be lengthened by equal parts.

Drawing not to scale

Helpful Layout Note:

- A)** Long arm's final placement is on **TOP** of bracket.
- B)** Tack weld bracket in position.
- C)** Close gate, place tape measure between bracket and output shaft.
- D)** With tape between bracket and output shaft, open gate and bend tape until tape is 90° from gate.
- E)** Take measurements of arms from bend in tape measure.

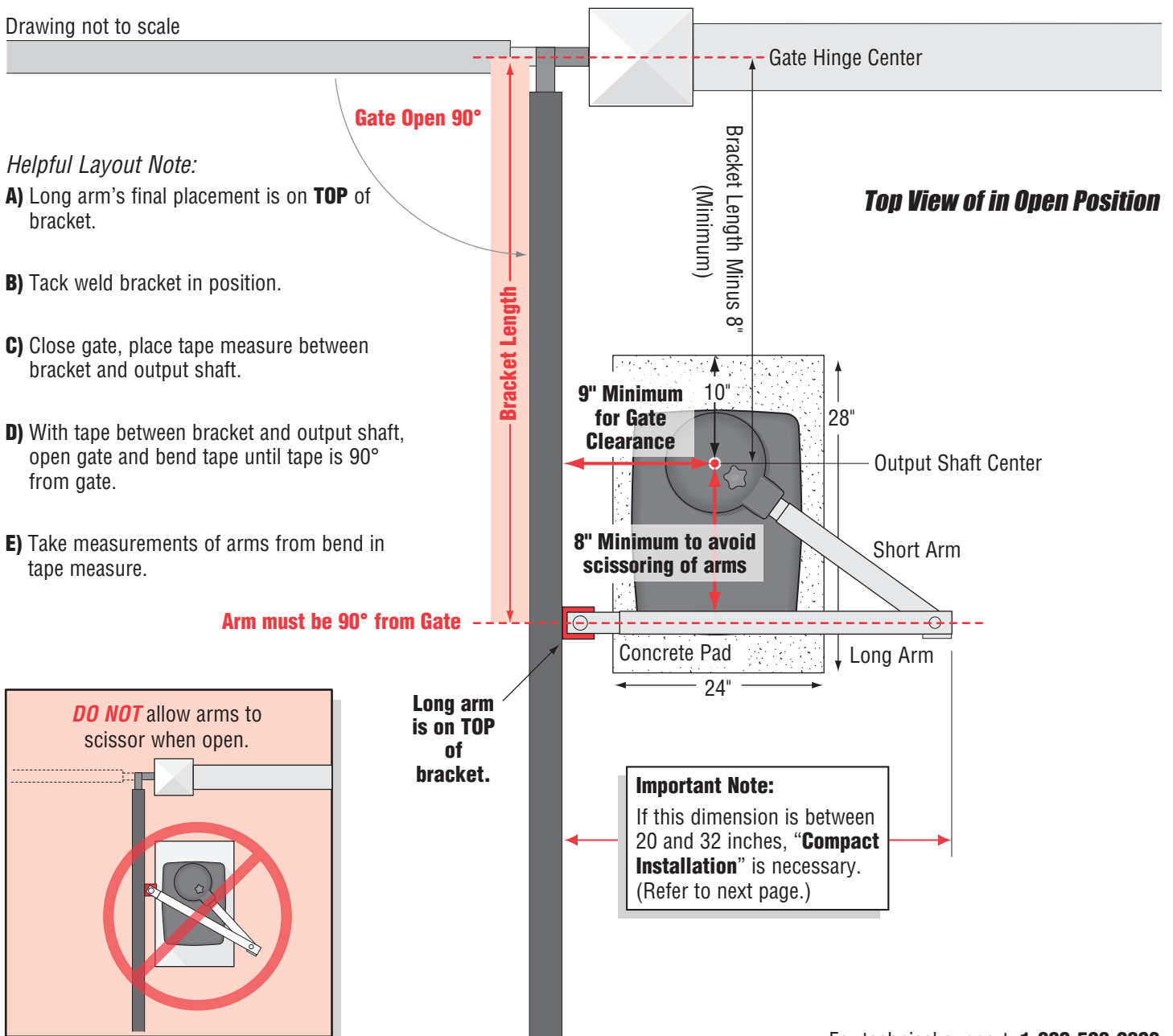

For technical support: 1-800-528-2806

COMPACT INSTALLATION LAYOUT

Compact Installation ONLY!

DO NOT use these measurements for a standard installation.
(For standard installation, see previous page.)

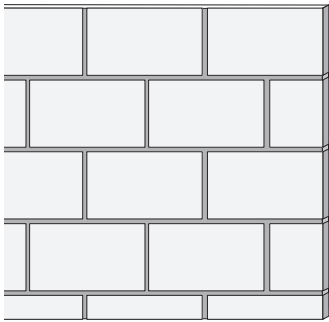

It is necessary to protect against the entrapment that could occur with this type of installation.
(See entrapment protection devices.)

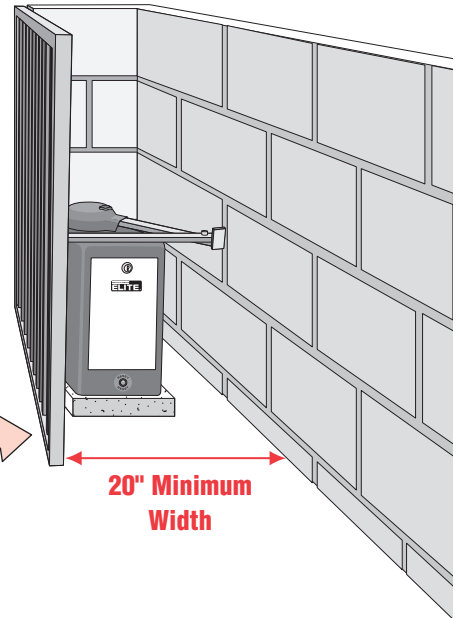

Gate Open

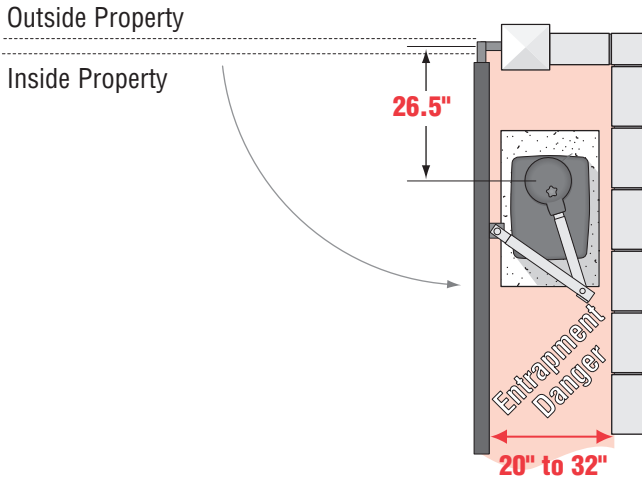

Gate Closed

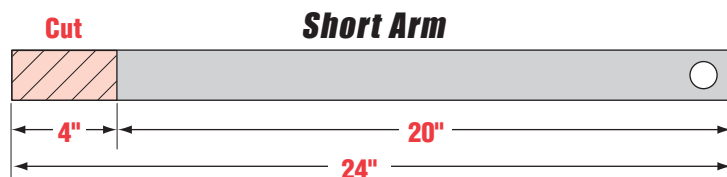
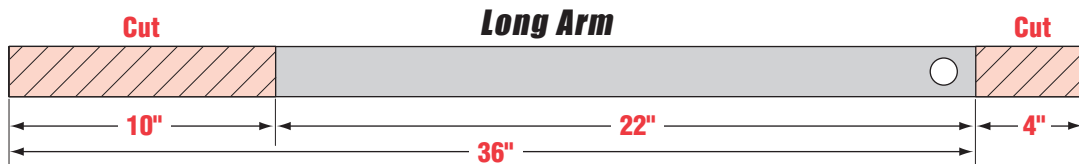
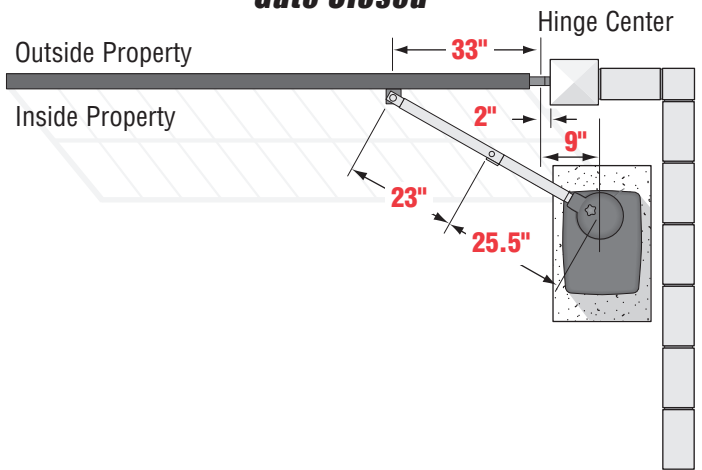

Follow the exact measurements, then cut the standard arm to meet the shorter measurements.

UPHILL DRIVEWAY INSTALLATION (OPTIONAL)

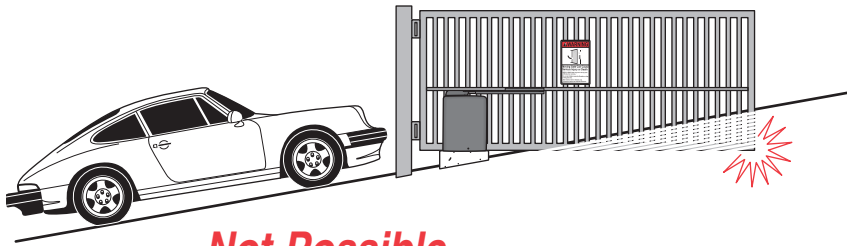

Not Possible
Gate hits driveway.

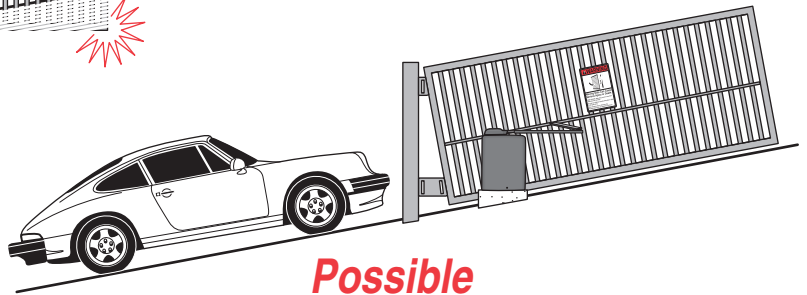

Possible
Special swivel arm and hinges are required.

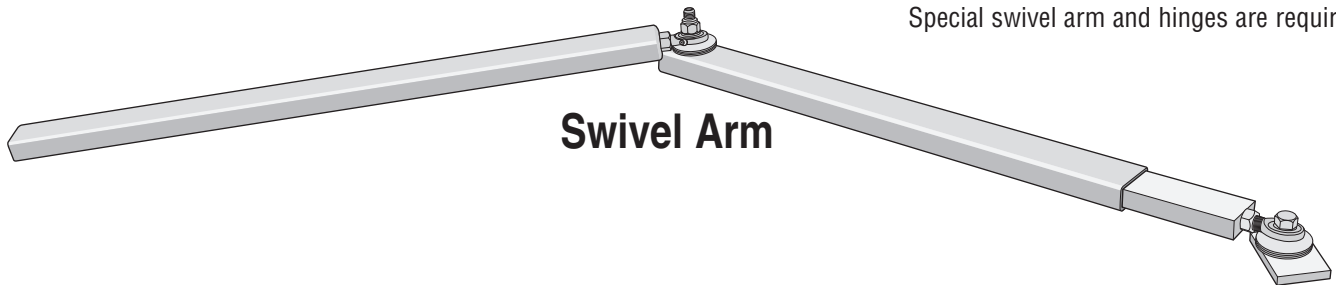

Swivel Arm

POST MOUNTING PLATE INSTALLATION (OPTIONAL)

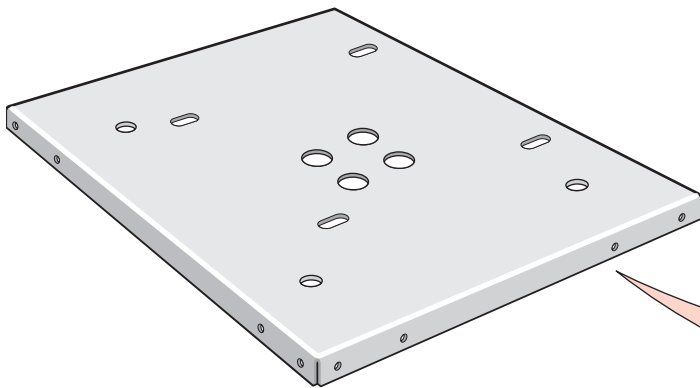

3" heavy steel posts can be U-bolted to mounting plate and cemented in ground.

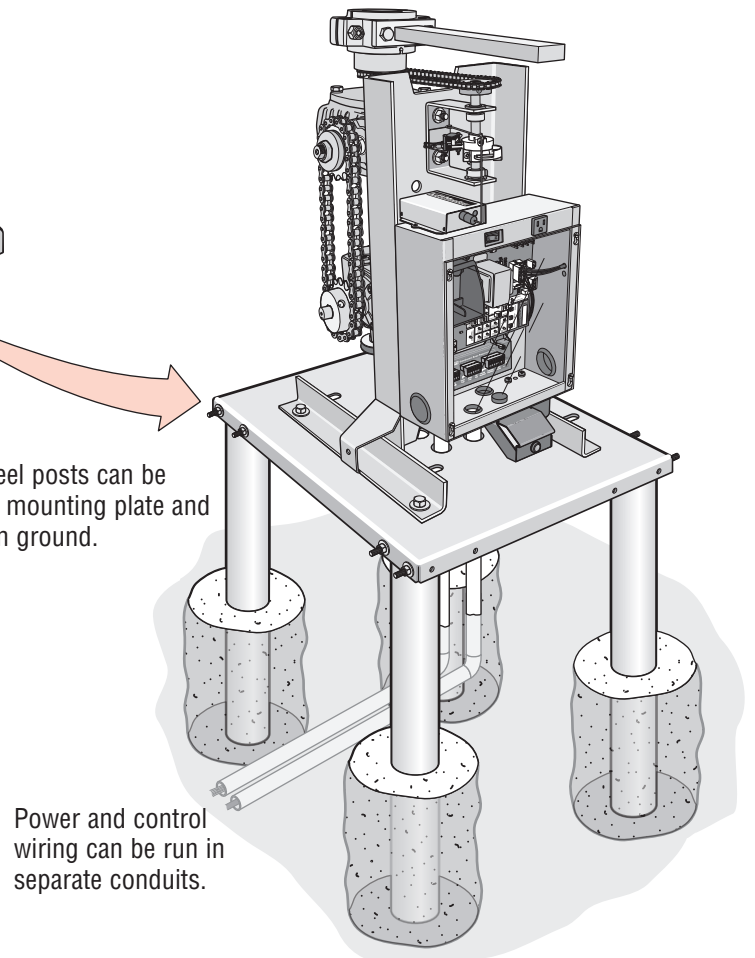

Power and control wiring can be run in separate conduits.

GATE ARM INSTALLATION

Incorrect Installation!

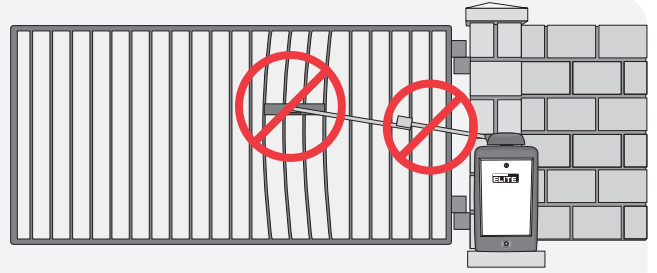

Gate Open

Gate Closed

Correct Installation

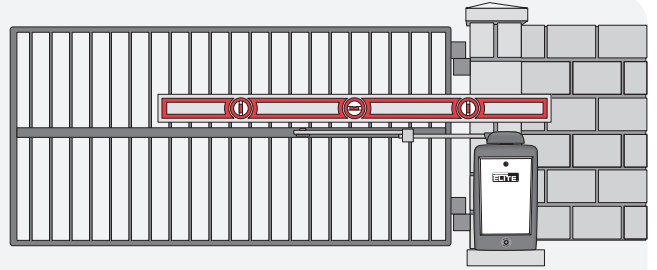
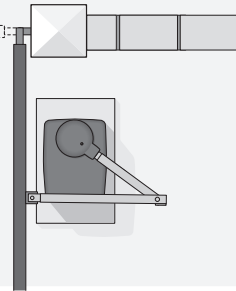

Once the gate arm measurements are calculated:

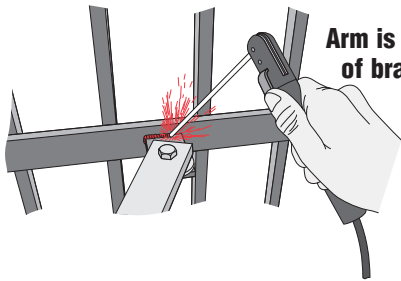

Arm is on TOP of bracket.

Weld the bracket on the gate.

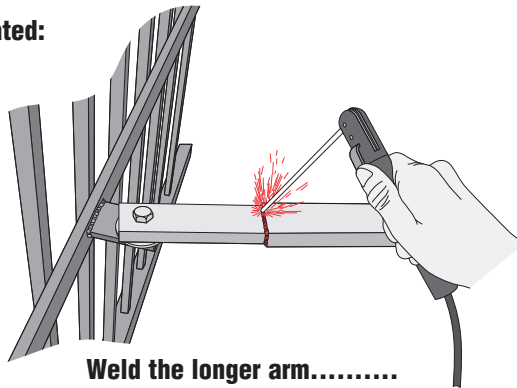

Weld the longer arm.....

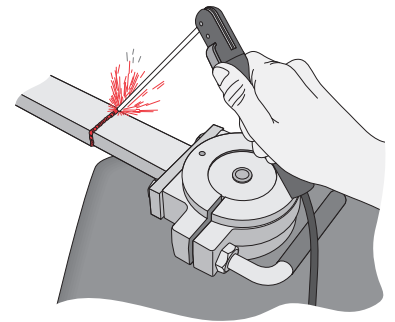

.....then weld the shorter arm.

Completely weld around the rectangular tubes and bracket!

OUTPUT SHAFT ADJUSTMENT

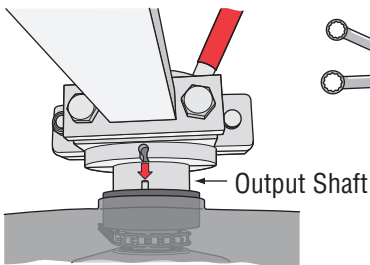

1 Fit pin in slot.

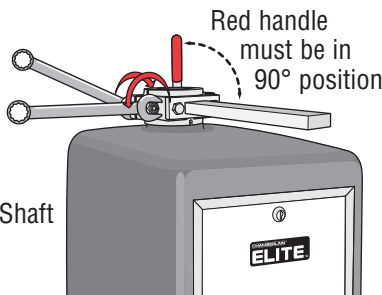

2 Tighten the nut.

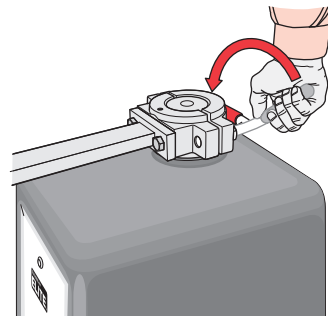

3 Tighten the handle.

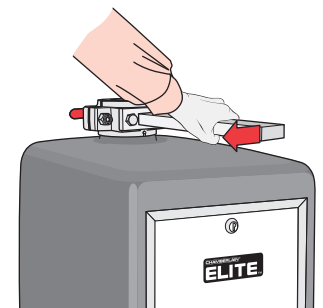

4 Pull the short arm away from the gate.
NO slippage should occur.
If it does, go back and tighten the nut.

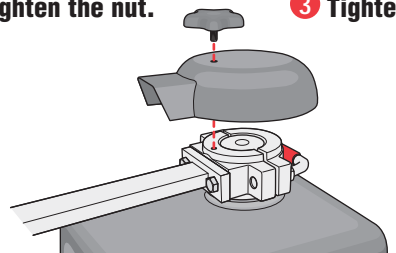

5 Replace cover and star knob.

CONTROL BOARD DESCRIPTION

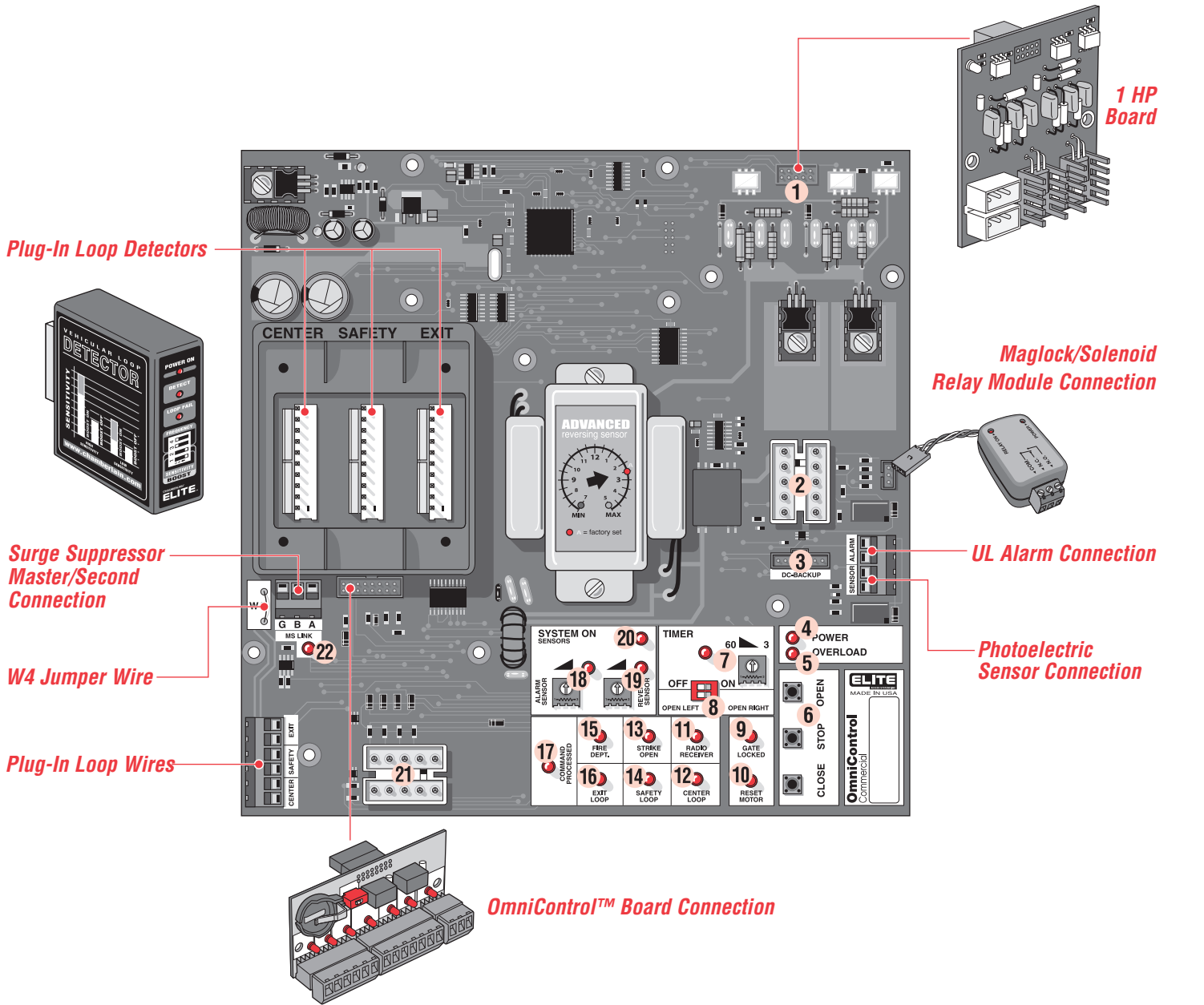

- | | |
|--|---|
| <ul style="list-style-type: none"> 1 1HP Connection - Factory installed CSW200UL1HP™ Models. 2 J3 Motor, Limit Switch, Maglock/Solenoid Connection 3 DC2000™ Back-Up Power or Reset Switch Connection 4 Circuit Board Power LED - Operator power OK when ON. 5 Overload LED - Operator power has overloaded when ON. 6 On-Board 3 Button Station - Close, Stop, Open commands. 7 Timer - Timed close. 8 Gate Opening Direction Selector - Open Left, Open Right. 9 Gate Locked LED - Maglock/Solenoid is activated when on. 10 Reset Motor LED - Cycle operator power when ON. 11 Radio Receiver LED - Radio transmitter is activated when ON. | <ul style="list-style-type: none"> 12 Center Loop LED - Center loop detector activated when ON. 13 Strike Open LED - Strike connected device activated when ON. 14 Safety Loop LED - Safety loop detector activated when ON. 15 Fire Dept LED - Key Switch activated when ON. 16 Exit Loop LED - Exit loop detector activated when ON. 17 Command Processed LED - Successful command executed. 18 Alarm Sensor - Limited Adjustment. 19 Reverse Sensor - Gate hit obstruction when ON. 20 System On LED - Operator is successfully performing a command. 21 J1 Surge Suppressor Data Connection 22 M/S Link LED - Data being transferred between master and second operators when ON. |
|--|---|

SURGE SUPPRESSOR TERMINAL CONNECTIONS

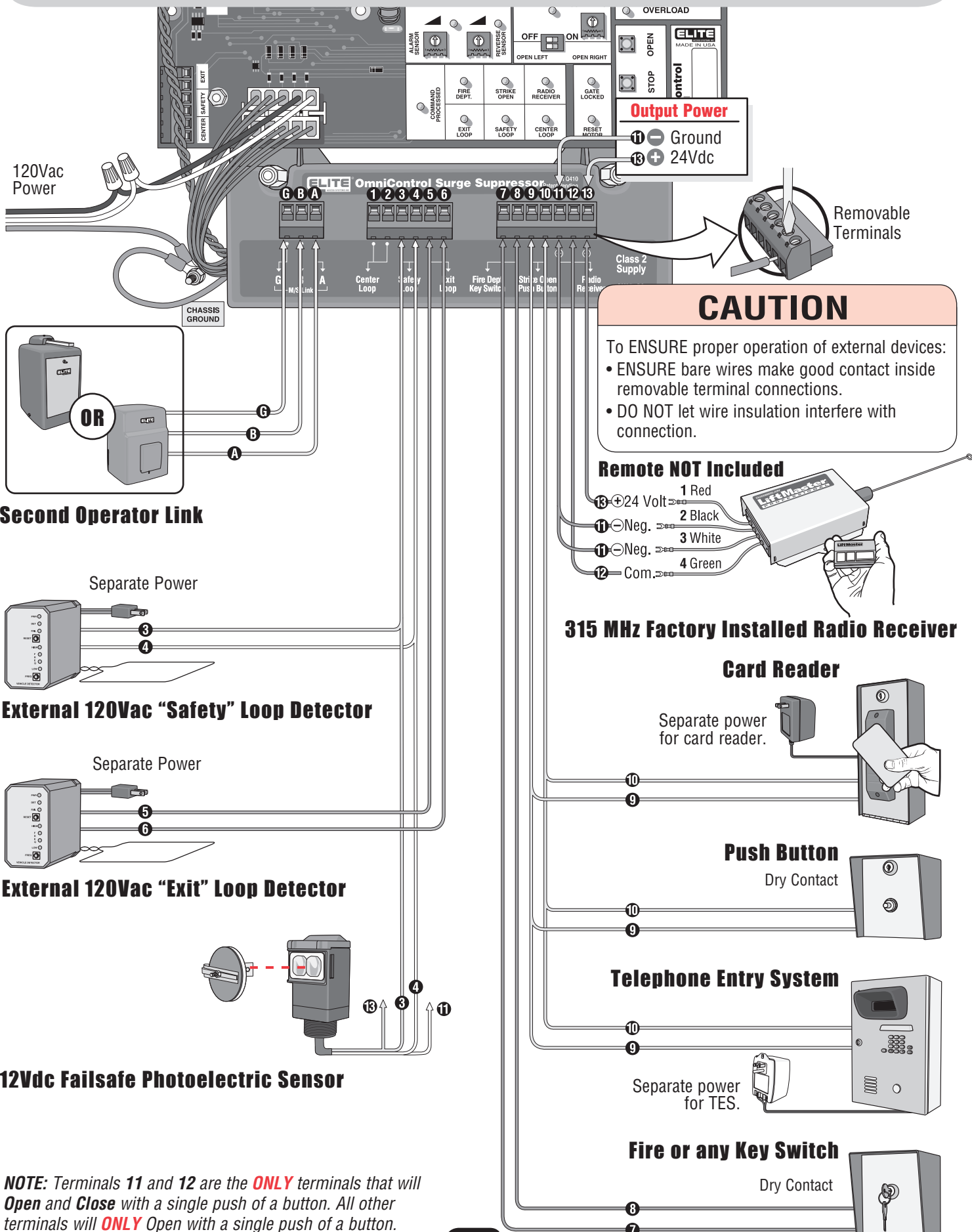

NOTE: Terminals 11 and 12 are the **ONLY** terminals that will **Open and Close** with a single push of a button. All other terminals will **ONLY** Open with a single push of a button.

Wiring

⚡ ⚠ WARNING

To reduce the risk of SEVERE INJURY or DEATH:

- ANY maintenance to the operator or in the area near the operator **MUST** not be performed until disconnecting the electrical power and locking-out the power. Upon completion of maintenance the area **MUST** be cleared and secured, at that time the unit may be returned to service.
- Disconnect power at the fuse box **BEFORE** proceeding.

Operator **MUST** be properly grounded and connected in accordance with local electrical codes.

NOTE: The operator should be on a separate fused line of adequate capacity.

- ALL electrical connections **MUST** be made by a qualified individual.

- DO NOT install ANY wiring or attempt to run the operator without consulting the wiring diagram. We recommend that you Install an optional reversing edge **BEFORE** proceeding with the control station installation.
- ALL power wiring should be on a dedicated circuit and well protected. The location of the power disconnect should be visible and clearly labeled.
- ALL power and control wiring **MUST** be run in separate conduit.
- **BEFORE** installing power wiring or control stations be sure to follow ALL specifications and warnings described below. Failure to do so may result in SEVERE INJURY to persons and/or damage to operator.
- DO NOT disconnect the built-in audio alarm or reset switch.

110Vac Power Wire	16 Gauge	14 Gauge	12 Gauge	10 Gauge	8 Gauge	4 Gauge
1/2 HP and Dual Motor	up to 150 FT	250 FT	400 FT	650 FT	1000 FT	2200 FT
1 HP	up to 75 FT	125 FT	200 FT	325 FT	500 FT	1100 FT

⚠ WARNING

To prevent SERIOUS INJURY or DEATH from a moving gate: DO NOT disconnect the built-in audio alarm or reset switch.

EARTH GROUND ROD INSTALLATION

CAUTION

To AVOID damaging gas, power, or other underground utility lines, contact underground utility locating companies **BEFORE** digging more than 18 inches (46 cm) deep.

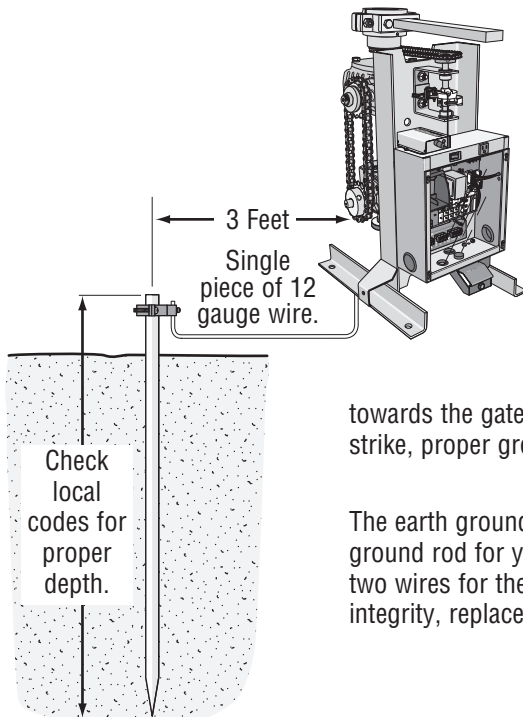

Proper grounding gives an electrical charge, such as from an electrical static discharge or a near lightning strike, a path from which to dissipate its energy safely into the earth.

Without this path, the intense energy generated by lightning could be directed towards the gate operator. Although nothing can absorb the tremendous power of a direct lightning strike, proper grounding can protect the gate operator in most cases.

The earth ground rod must be located within 3 feet from the gate operator. Use the proper type earth ground rod for your local area. The ground wire must be a single, whole piece of wire. Never splice two wires for the ground wire. If you should cut the ground wire too short, break it, or destroy its integrity, replace it with a single wire length.

110Vac POWER CONNECTION

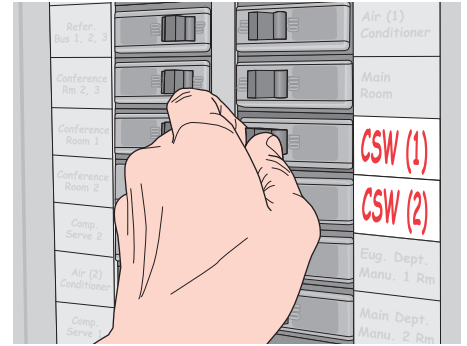
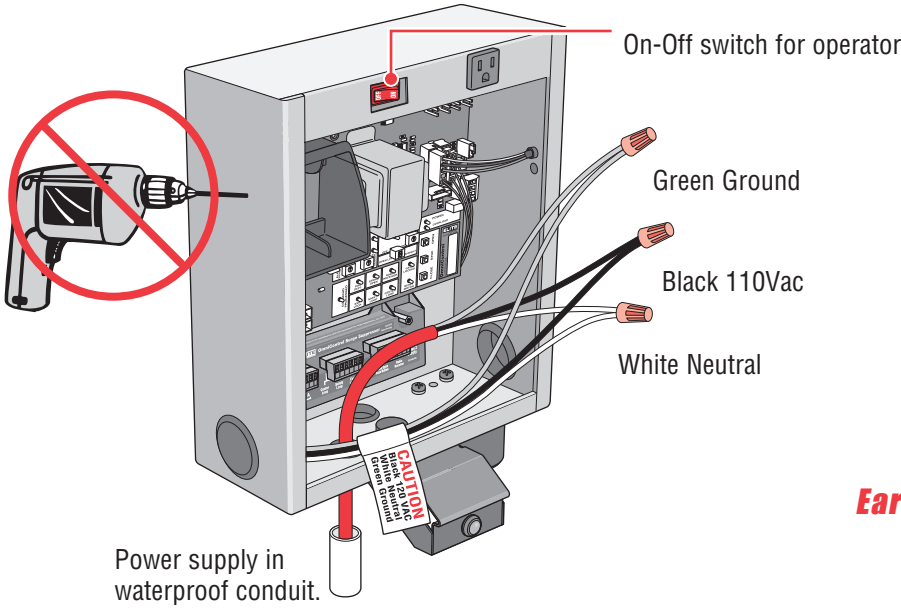

Use a 20 amp dedicated circuit for each operator.
Input power 120Vac, 60 Hz.

Earth Ground Rod Highly Recommended!

See previous page.

110Vac Power Wire	16 Gauge	14 Gauge	12 Gauge	10 Gauge	8 Gauge	4 Gauge
1/2 HP and Dual Motor	up to 150 FT	250 FT	400 FT	650 FT	1000 FT	2200 FT
1 HP	up to 75 FT	125 FT	200 FT	325 FT	500 FT	1100 FT

HEATER POWER CONNECTION

Connect the black, white and ground wire from the heater to the 110Vac power supply as shown. When the heater switch is left in the "ON" position, the heater will turn on and off automatically when needed.

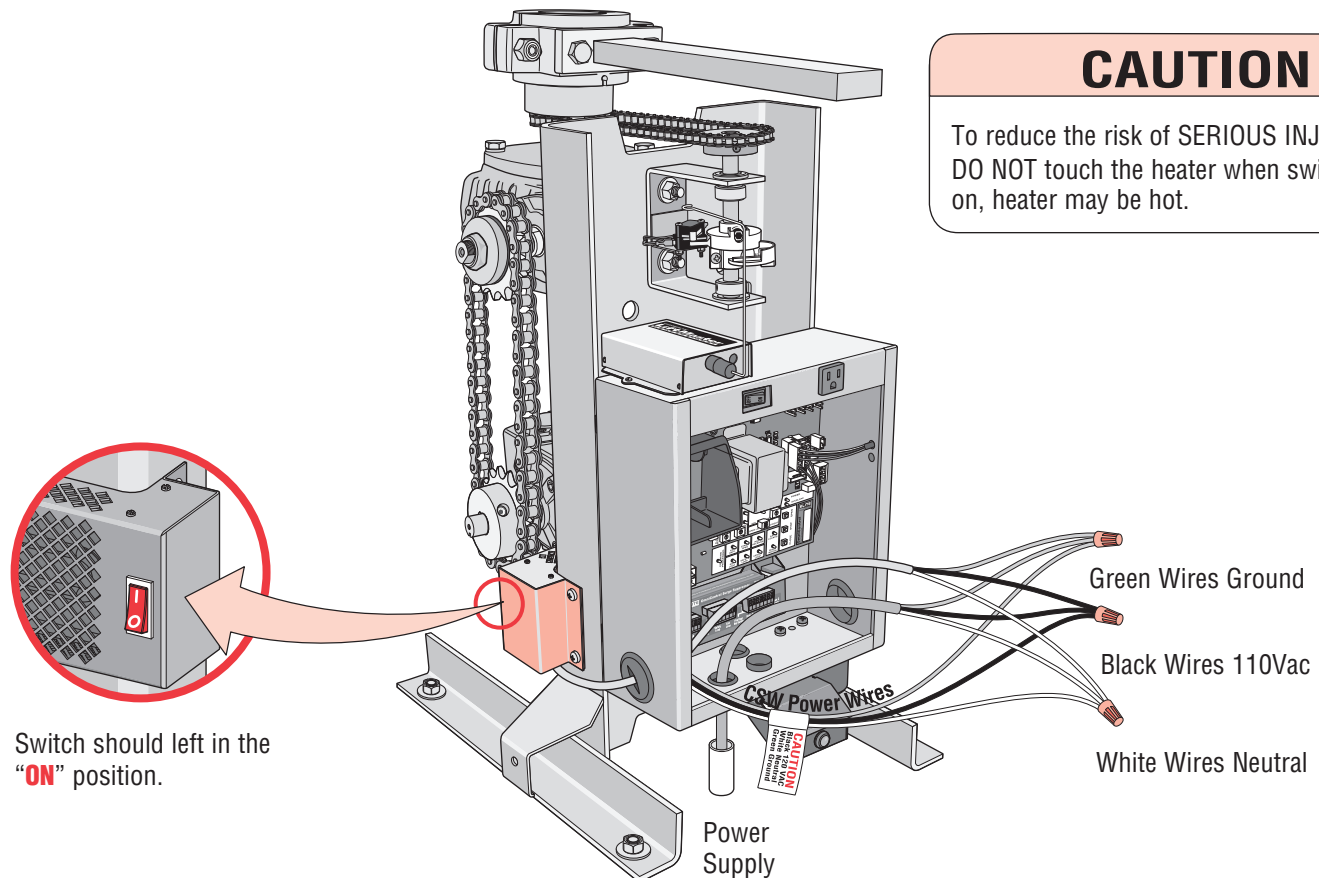

CAUTION

To reduce the risk of SERIOUS INJURY:
DO NOT touch the heater when switch is on, heater may be hot.

LINKING MASTER / SECOND OPERATORS

Use a 20 amp dedicated power circuit for each operator.

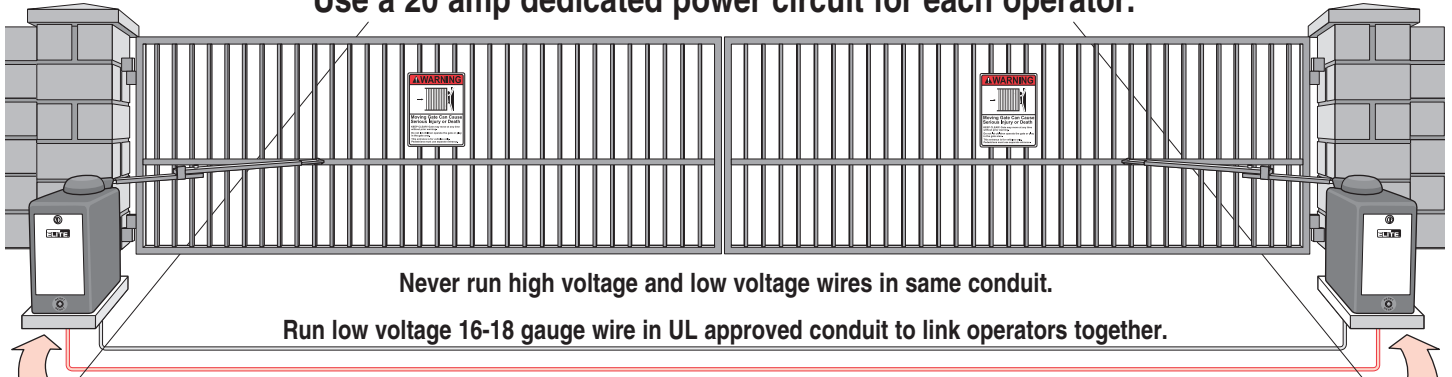

Master Board

Master/Second control boards are interchangeable.

Second Board

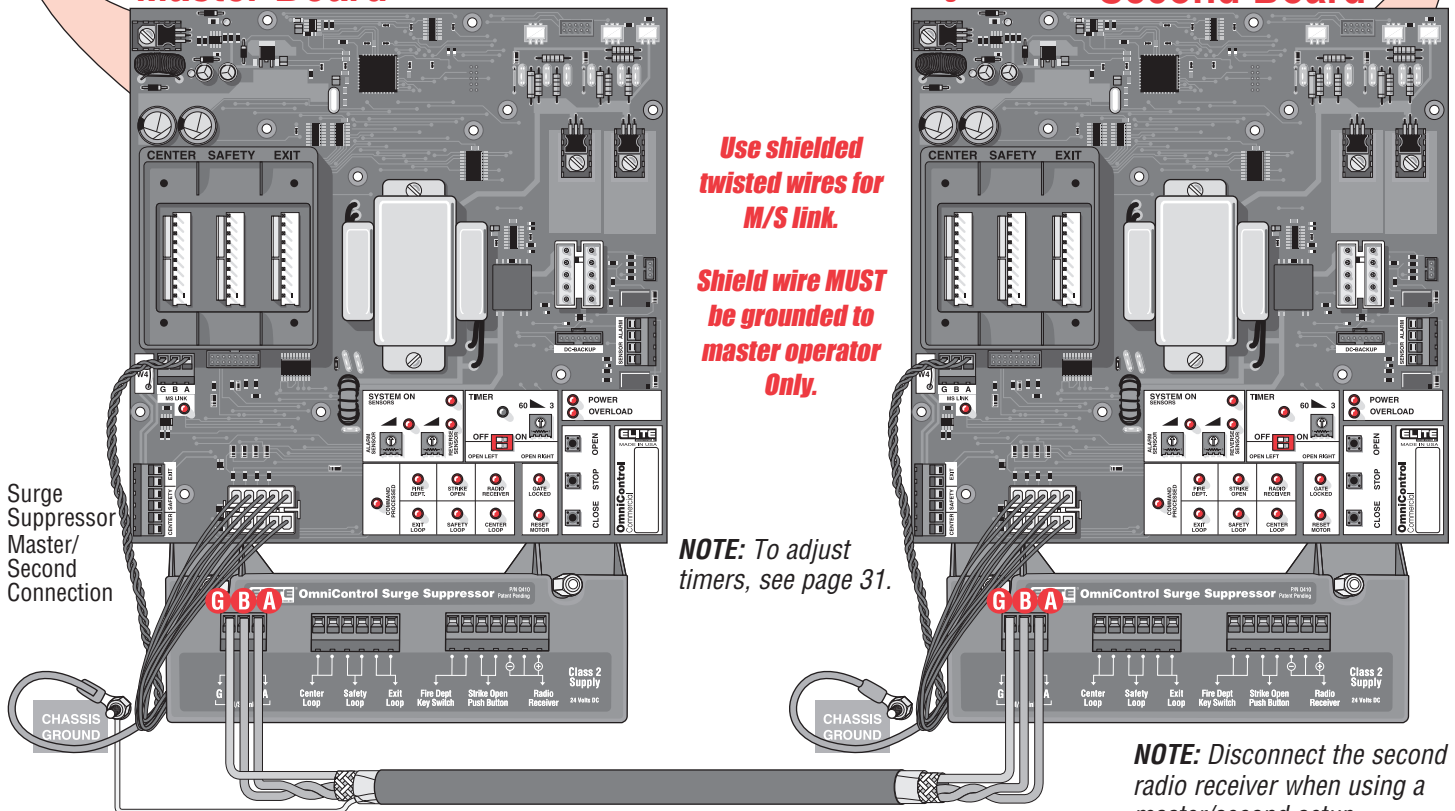

Shield Wire

**Connect Master M/S Link G to Second M/S Link G.
Connect Master M/S Link B to Second M/S Link B.
Connect Master M/S Link A to Second M/S Link A.**

NOTE: Disconnect the second radio receiver when using a master/second setup.

Partial Master/Individual Control

In order for the following operation to occur, follow the instructions.

Example: There is a double gate, the entry gate is to be opened with a remote control and the exit gate with a free exit loop. Only one safety loop system is to open both gates, and a fire department switch should open both gates at the same time.

1. Connect the radio receiver to entry gate only.
2. Connect the exit loop to exit gate only.
3. Connect the safety loop to both entry and exit gates (observe polarity of voltage).
4. Connect the fire department switch to both entry and exit gates (observe polarity of both operators).

SOLENOID/MAGLOCK RELAY CONNECTION

Connection of a solenoid or magnetic lock can be made using the J7 board connector and "Optional" Relay Adapter Module.

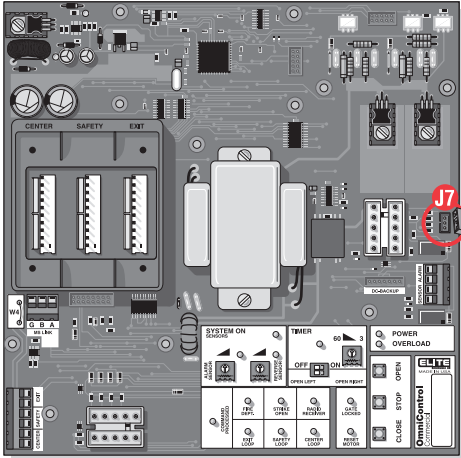

Relay Contact Rating
2 Amp - 125 AC/DC
2 Amp switching load capability

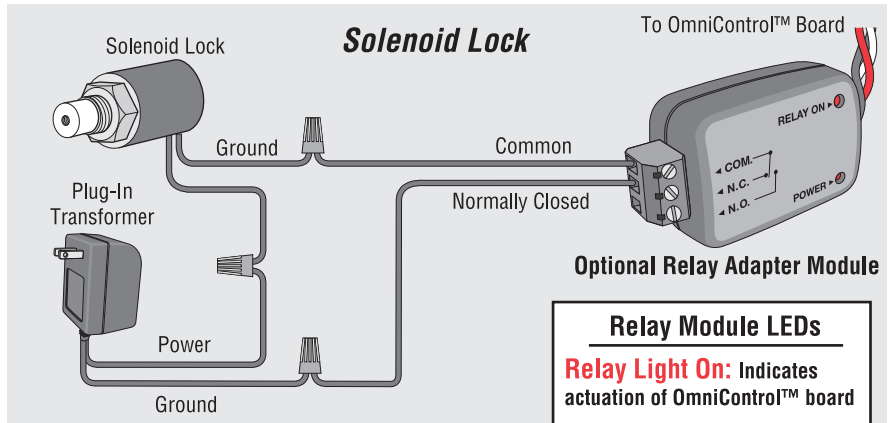

Relay Module LEDs
Relay Light On: Indicates actuation of OmniControl™ board
Power Light On: Indicates power is being received

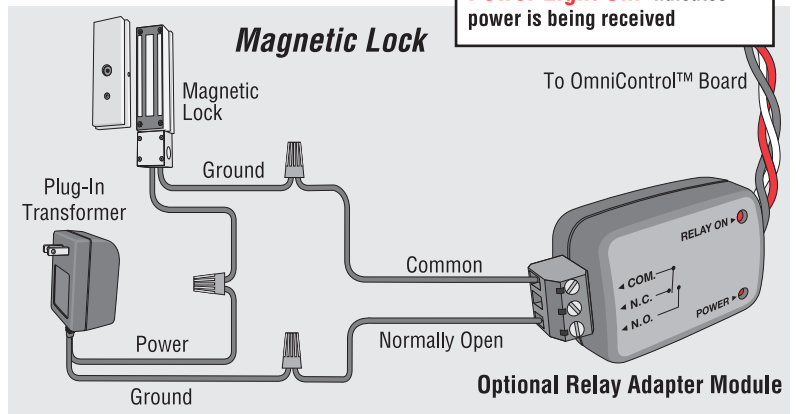

FACTORY INSTALLED DC2000™ CONNECTION

DC2000™ Startup

- 1 Plug in the 12 pin plug into the DC2000™ control unit. Make sure the “System ON” and “Charge OK” LEDs are lit. If the “Battery Low” led comes on, the battery needs to charge before it can be used.
- 2 Make sure “Gate Direction” setting on DC2000™ is set the same as the OmniControl™ board setting. See Adjustments.
- 3 Adjust “Reverse Sensor” setting. See Adjusting Reverse Sensor(s).

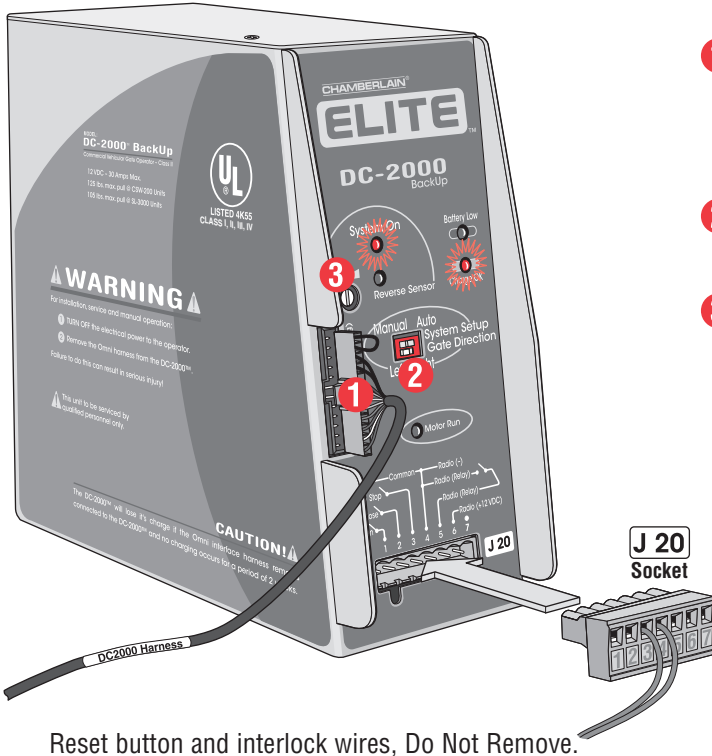

Reset button and interlock wires, Do Not Remove.

	110Vac Power Failure	110Vac Power On, OmniControl™ Board Malfunction
Manual Mode	Push and Hold to operate gate.	Turn the 110Vac power off then push and Hold to operate gate.
Auto Mode	Gate automatically opens.	Turn the 110Vac power off then gate opens automatically.

NOTE: All devices wired to the DC2000™ MUST be **dedicated** to it alone. Normal operation will be controlled by separate devices wired to the OmniControl™ board and surge suppressor.

Example: If the DC2000 is “automatically opening” the gate due to a power failure (auto mode), any manual command such as “One-Button”, “Three Push Button”, “Key Switch”, “Photoelectric Sensor” or “Edge Sensor” will cancel the automatic mode of the DC2000™. After such cancellation, the DC2000™ will continue to operate in “manual mode” until 110Vac power is restored.

DC2000™ 12Vdc Radio Receiver (Not Provided)

The DC2000™ needs a separate 12Vdc radio receiver to give remote commands to the operator during a power failure.

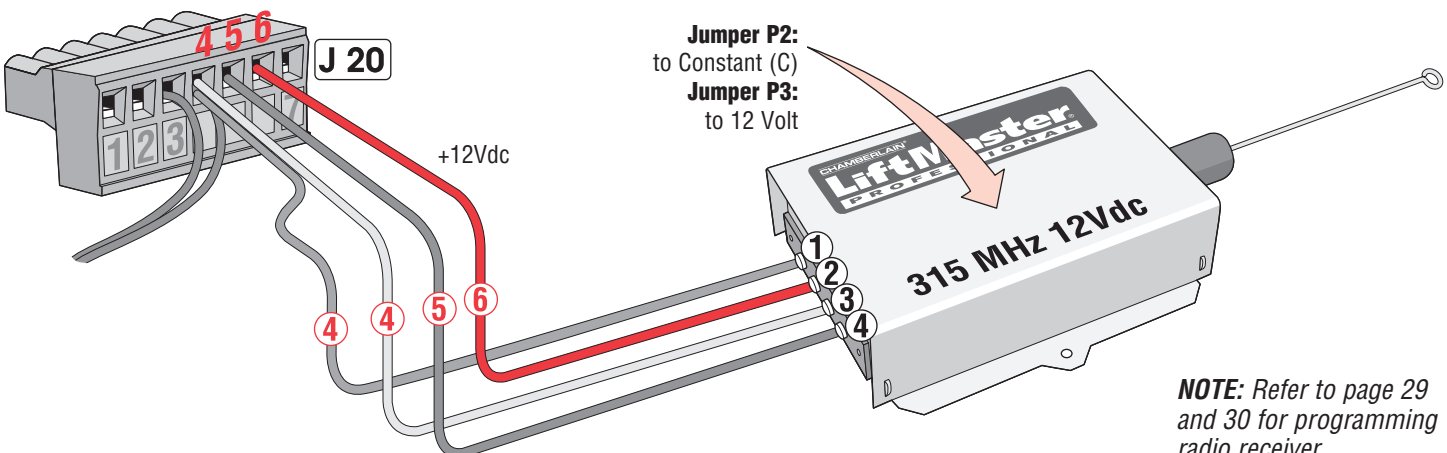

NOTE: Refer to page 29 and 30 for programming radio receiver.

DC2000™ DEVICE WIRING

Manually Operated DC2000™ Devices

Manual external devices should be dry-contact which do not consume any current like push buttons or a key switch.

Key switch is for property owner's emergency access ONLY. DO NOT FOR USE FOR A EMERGENCY FIRE/POLICE KEY ACCESS.
Contact your local Fire/Police municipalities for more information on correct Fire/Police emergency key access.

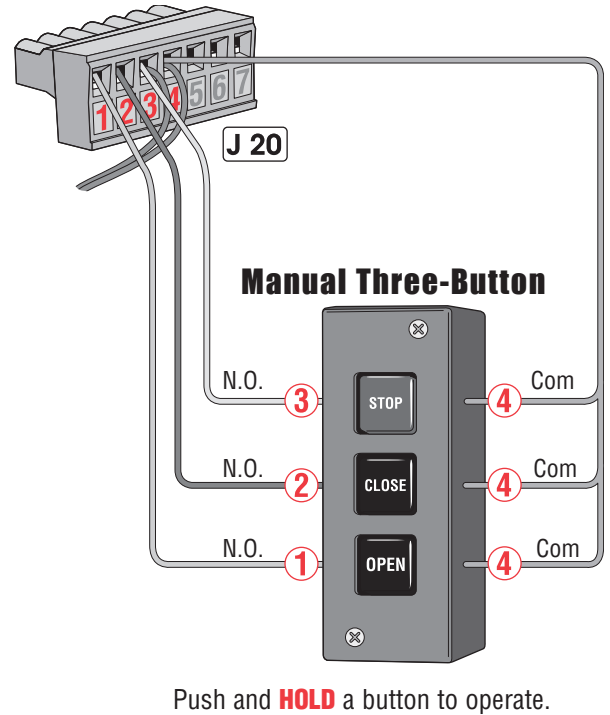
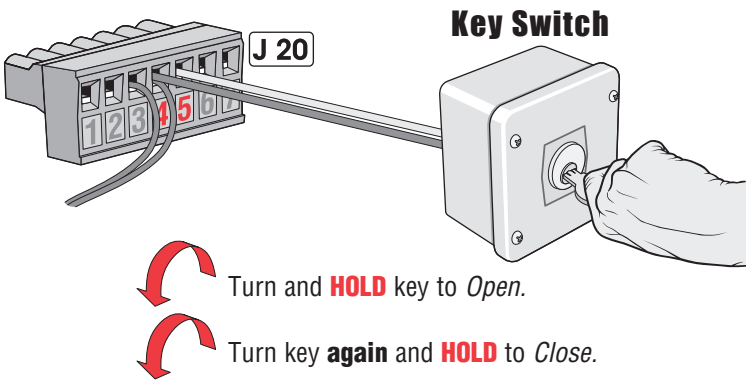
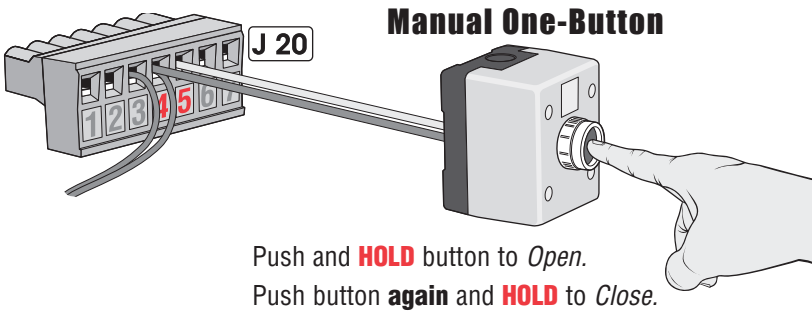

DC2000™ Entrapment Protection Devices

It is recommended using separate entrapment protection devices to maintain gate safety when the DC2000™ is needed for any reason. The entrapment protection devices connected to the OmniControl™ board and surge suppressor **WILL NOT** protect the gate when there is a AC power failure and the DC2000™ is used.

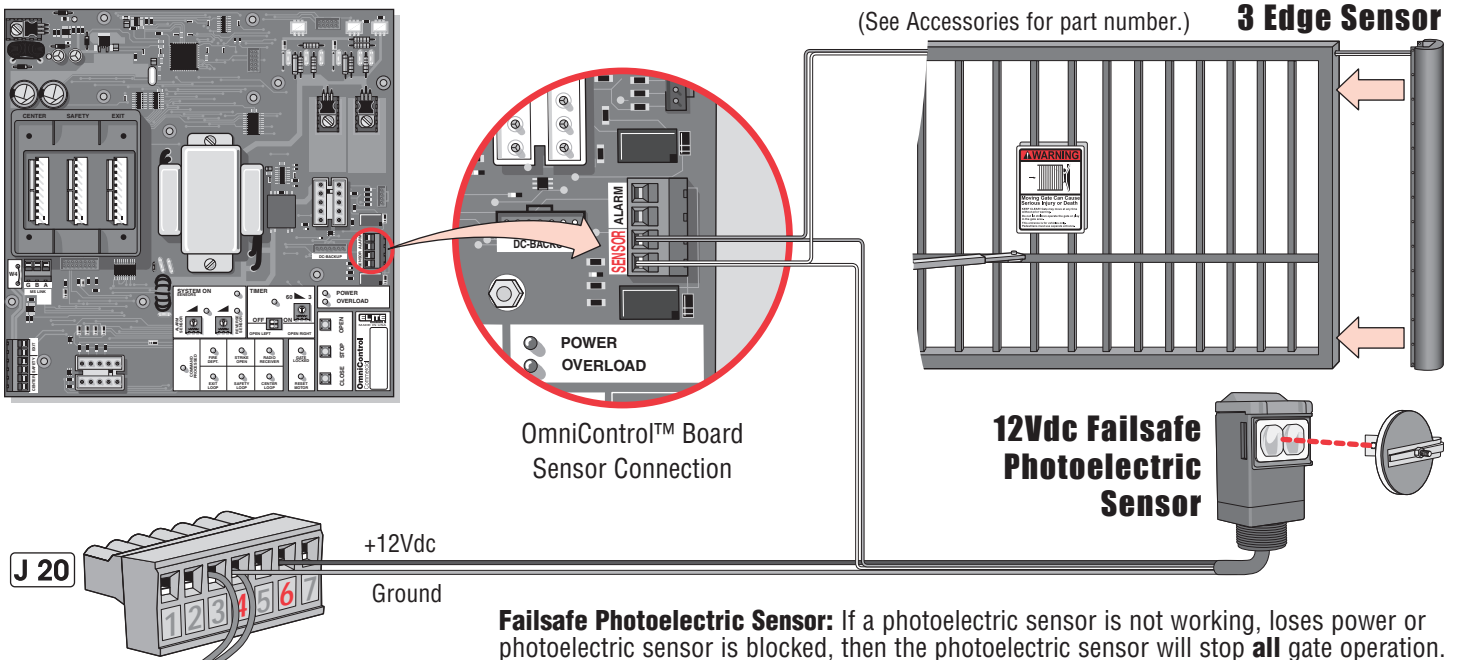

PLUG-IN LOOP DETECTOR WIRING

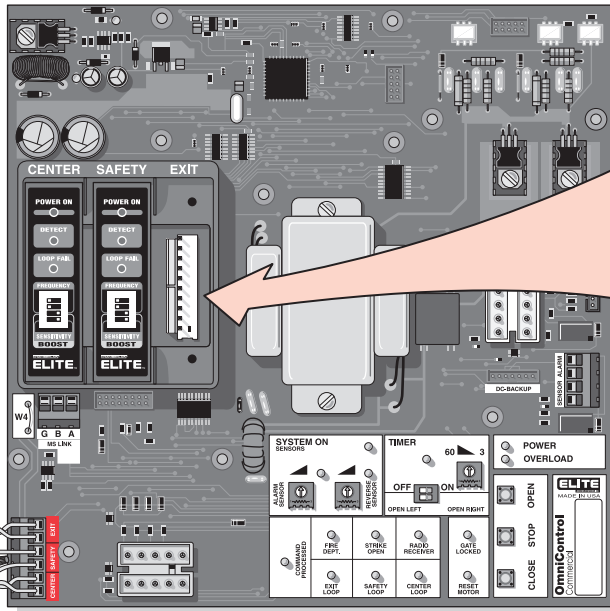

Plug-In Loop Detectors
(Sold Individually)

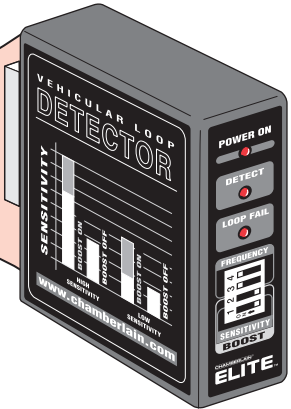

The wire **MUST** be twisted together **6 twists per foot** from the end of the loop to the control board.

Series Connected

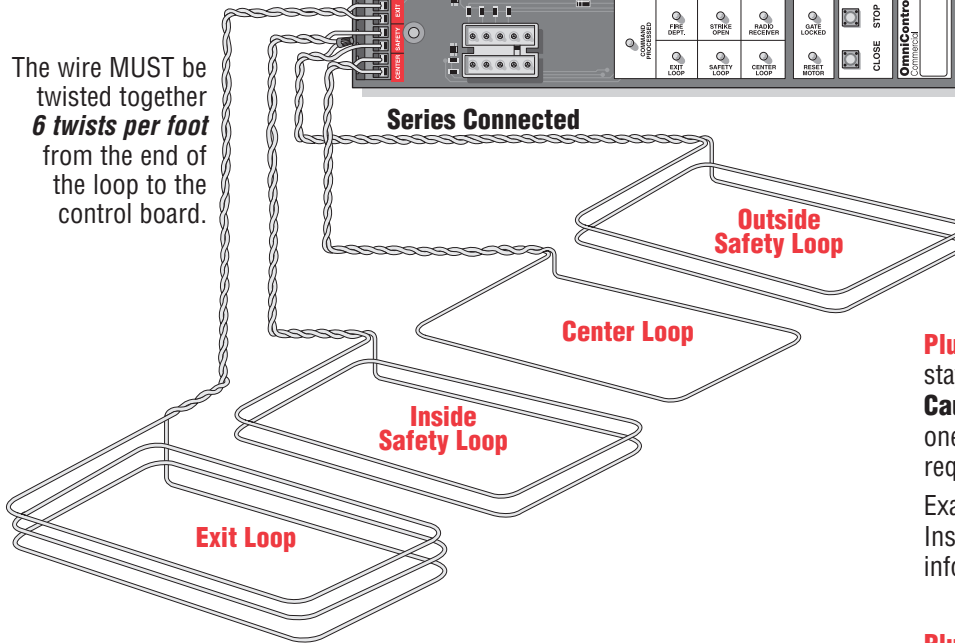

CAUTION

To **AVOID** damaging control board, disconnect all power to operator before installing plug-in loop detectors. Use a different frequency for every loop detector installed.

Plug-In “Center” Loop Detector: Allows gate to stay open when vehicles are obstructing path.

Caution: This option is for all vehicles including ones less than 14 feet long. Center loop system requires two safety loops.

Example of a 1 wire loop. (See “Installing Insulated Loop Wire” on next page for more information.)

Plug-In “Safety” Loop Detector: Allows gate to stay open when vehicles are obstructing path. Caution: Suggested for vehicles 14 feet or longer.

If the “**Inside**” and “**Outside**” safety loops are connected to the same loop detector:

- They should be series connected to the detector.
- Have the same dimensions.
- Have the same number of wire turns.

Example of a inside and outside 2 turn loop connected in series. (See “Installing Insulated Loop Wire” on next page for more information.)

Plug-In “Exit” Loop Detector: Allows gate to automatically open for exiting vehicles.

Example of a 3 wire loop. (See “Installing Insulated Loop Wire” on next page for more information.)

NOTE: Refer to the plug-in loop detector manual for more specific information.

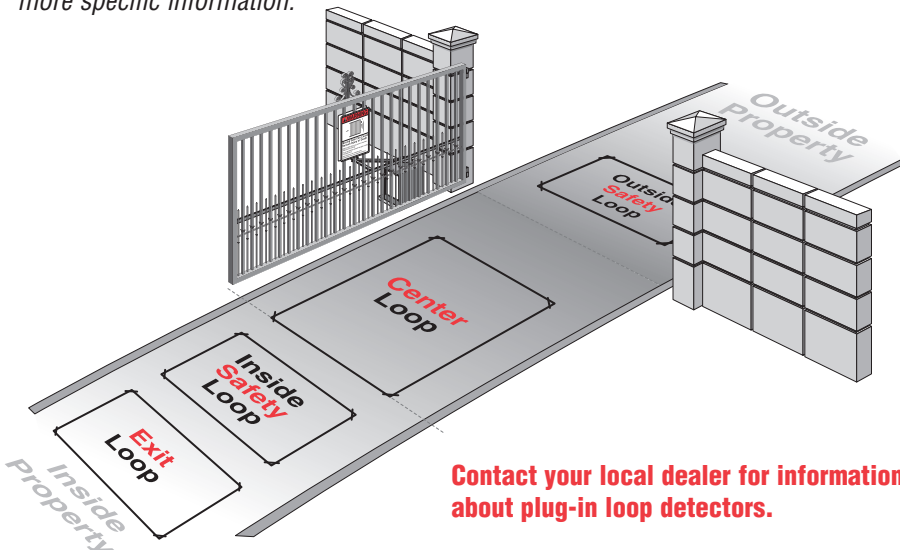

Contact your local dealer for information about plug-in loop detectors.

110Vac EXTERNAL LOOP DETECTOR WIRING

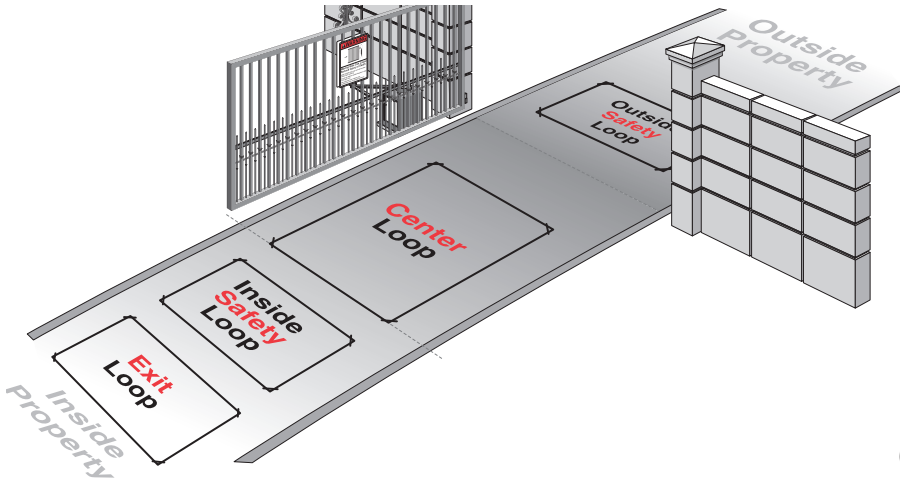

110Vac “Center” Loop Detector: Allows gate to stay open when vehicles are obstructing path. Caution: This option is for all vehicles including ones less than 14 feet long. Center loop system requires two safety loops.

110Vac “Safety” Loop Detector: Allows gate to stay open when vehicles are obstructing path. Caution: Suggested for vehicles 14 feet or longer. If a vehicle is shorter, a center loop system is recommended and should be installed.

If the “Inside” and “outside” safety loops are connected to the same loop detector:

- They should be series connected to the detector.
- Have the same dimensions.
- Have the same number of wire turns. (See table below.)

110Vac “Exit” Loop Detector: Allows gate to automatically open for exiting vehicles.

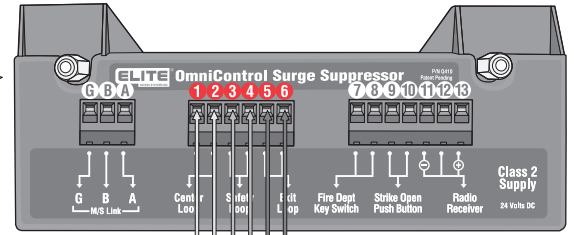

(Sold Individually)

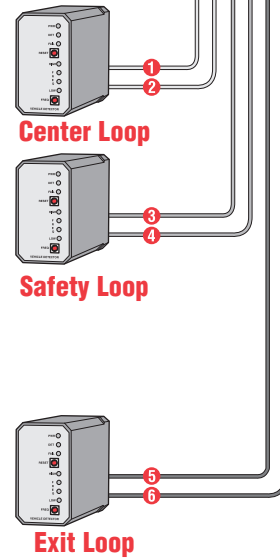

NOTE: Use separate 110Vac power for each loop detector.

Installing Insulated Loop Wire

Number of Wire Turns Needed for Loop Sizes

Loop Perimeter	Number of Wire Turns
10 feet to 13 feet	4
14 feet to 26 feet	3
27 feet to 80 feet	2
80 feet and up	1

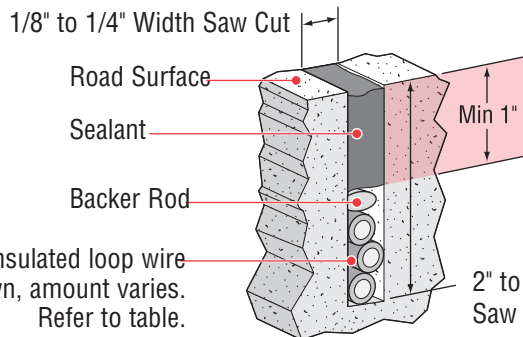
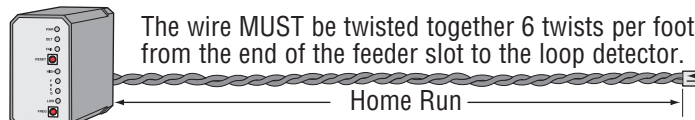
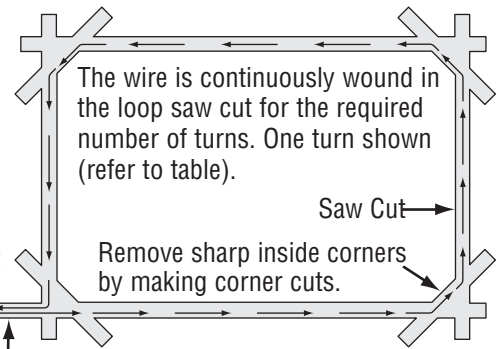

Recommended Loop Wire XLPE 12-18 gauge
(Use heavier wire gauge for a more durable loop.)

NOTE: Wire mesh or reinforcement imbedded in the road surface should be cut away a minimum of 6 inches from the perimeter of the loop.

Contact your local dealer for more information about loop detectors.

Insulated loop wire
3 turns shown, amount varies.
Refer to table.

ENTRAPMENT PROTECTION DEVICES

Contact Sensors (Edge Sensor)

3 Edge Contact Sensor

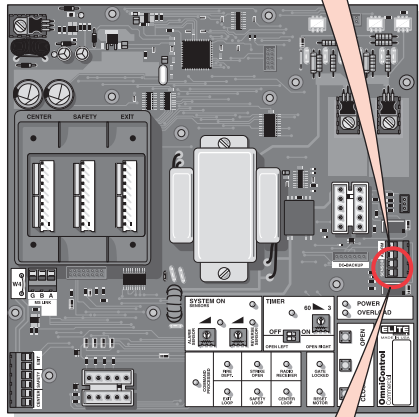
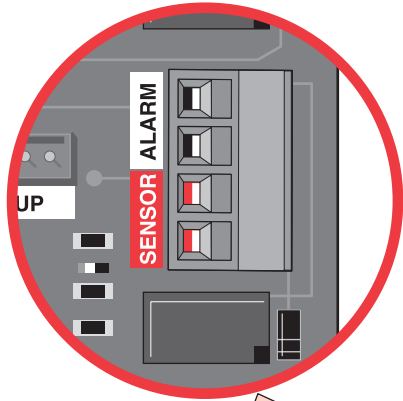

⚠ WARNING

To prevent SERIOUS INJURY or DEATH from a moving gate:

- Locate entrapment protection devices to protect in BOTH the open and close gate cycles.
- Locate entrapment protection devices to protect between moving gate and RIGID objects, such as posts or walls.

NOTE: When touched, these electrically activated edge sensors immediately signal the gate operator to stop and reverse. Property owners are obligated to test edges monthly.

UL Listed 3 sided Edge Sensor
(See Accessories for part number.)

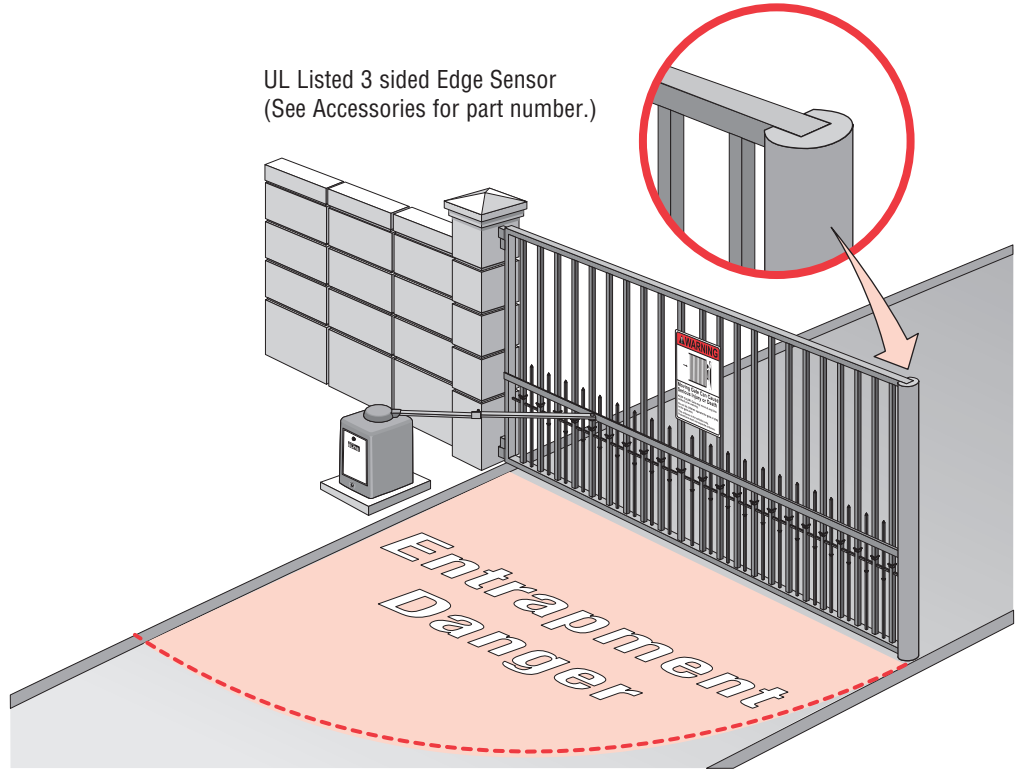

Open and Close Contact Sensors

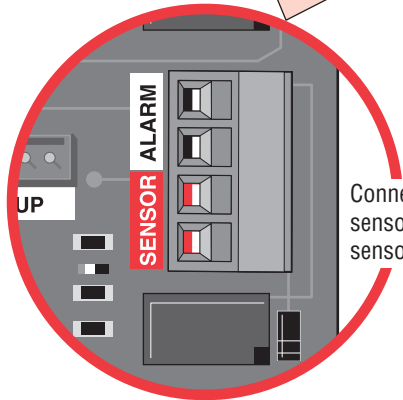

Connect both edge sensors parallel to sensor connector.

Open Sensor
Close Sensor

UL Listed Edge Sensors
(See Accessories for part number.)

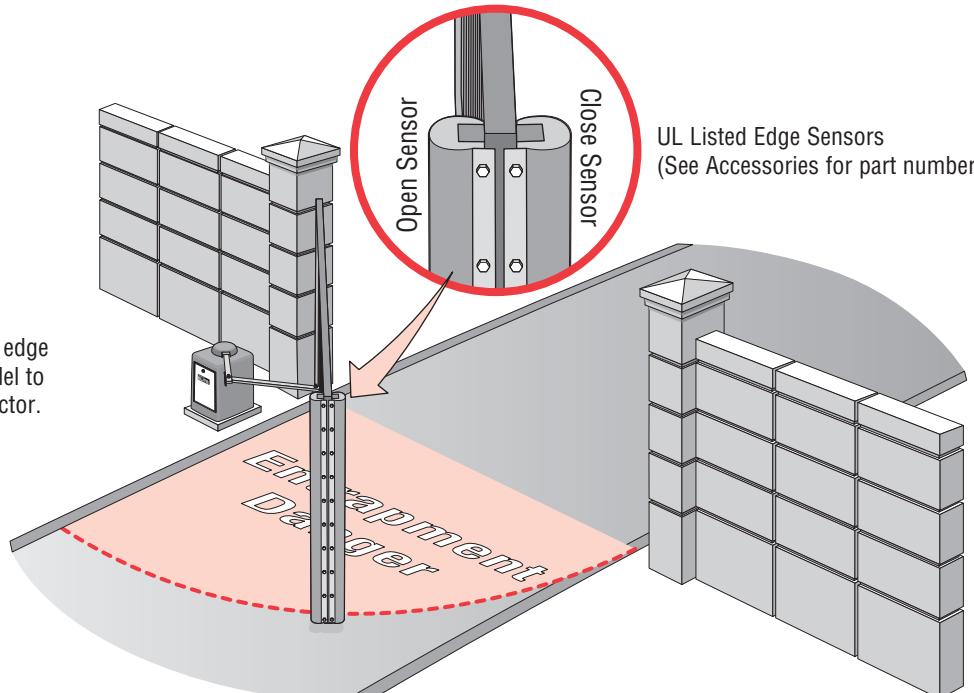

Contact your local dealer for more information about edge sensors.

ENTRAPMENT PROTECTION DEVICES

Non-Contact Sensors (12Vdc Photoelectric Sensors)

⚠️ WARNING

- To prevent SERIOUS INJURY or DEATH from a moving gate:
- Locate entrapment protection devices to protect in BOTH the open and close gate cycles.
 - Locate entrapment protection devices to protect between moving gate and RIGID objects, such as posts or walls.

NOTE: Property owners are obligated to test photoelectric sensors monthly.

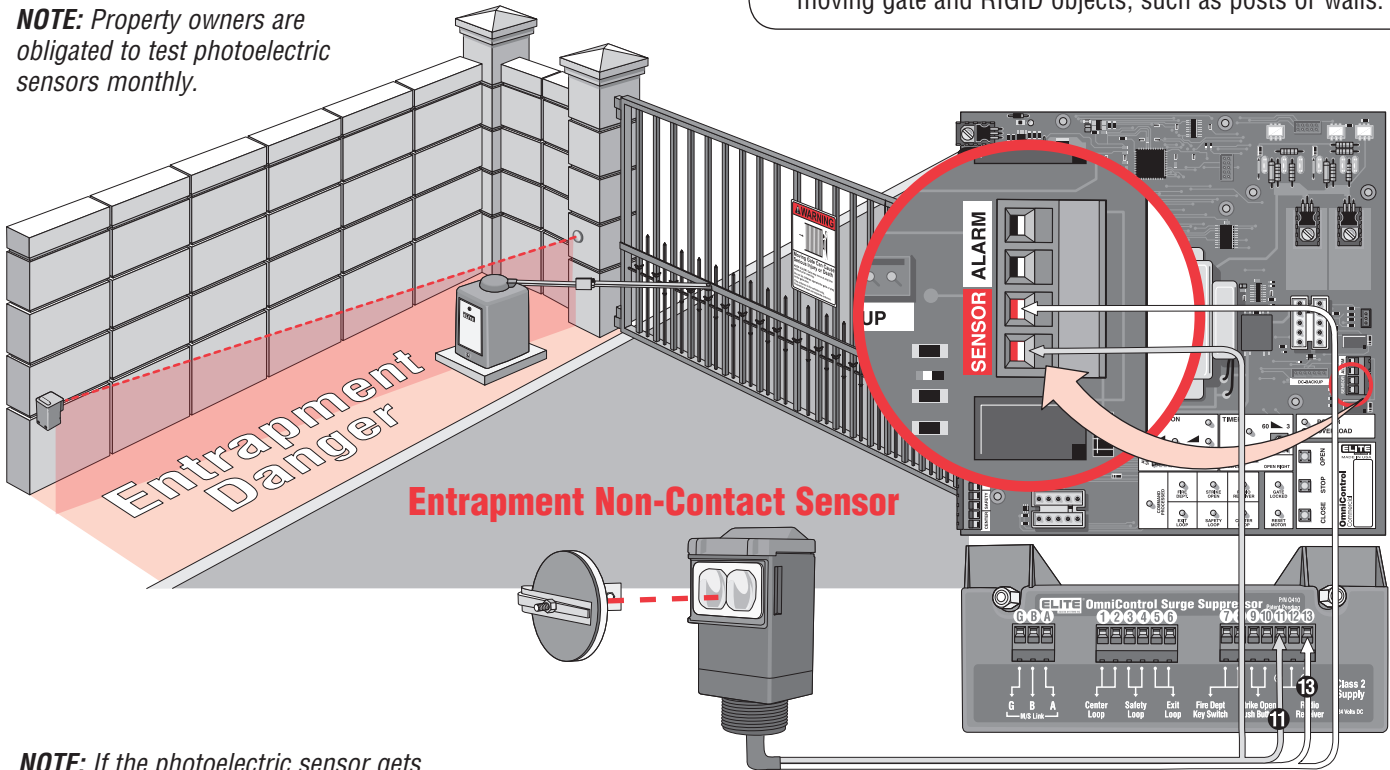

NOTE: If the photoelectric sensor gets blocked while the gate is closing, it will stop and reopen. The gate will remain open until the obstruction is cleared.

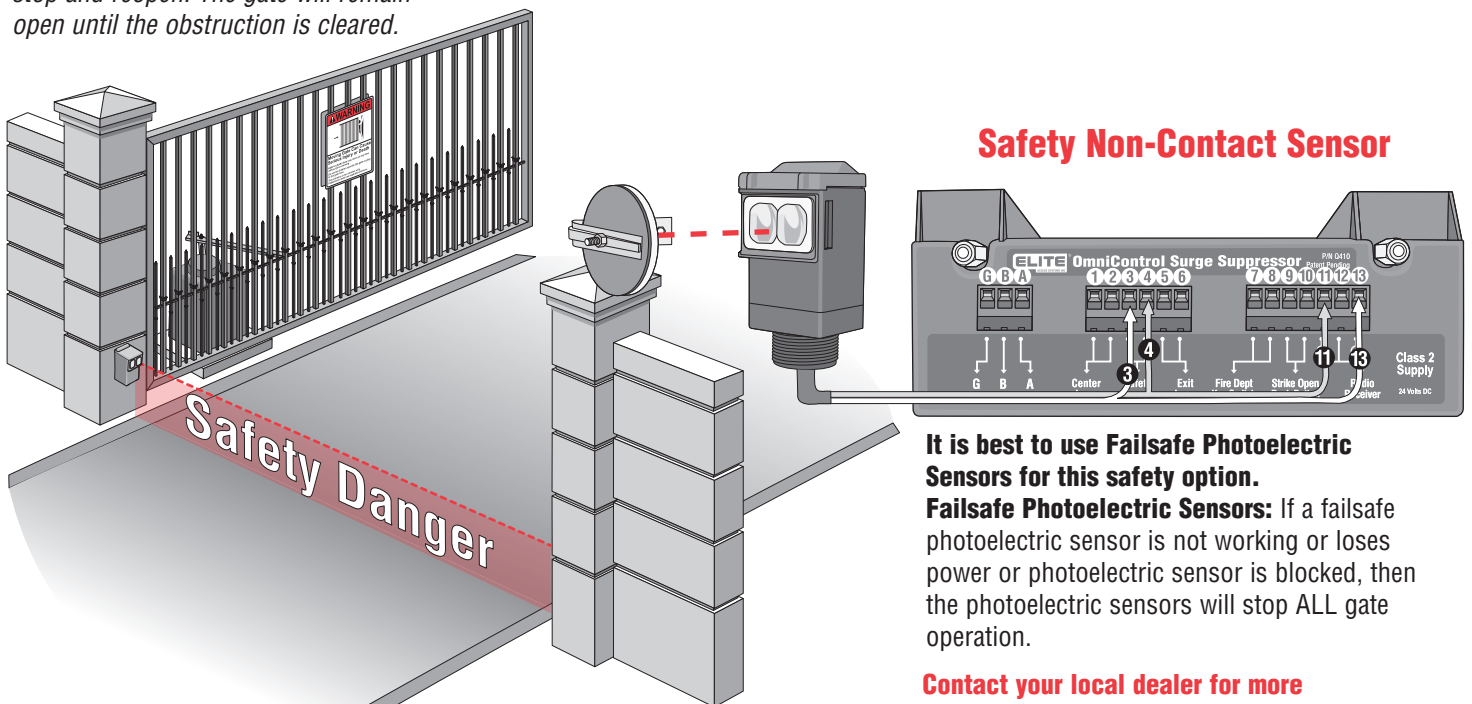

It is best to use **Failsafe Photoelectric Sensors** for this safety option.
Failsafe Photoelectric Sensors: If a failsafe photoelectric sensor is not working or loses power or photoelectric sensor is blocked, then the photoelectric sensors will stop ALL gate operation.

Contact your local dealer for more information about photoelectric sensors.

Adjustments

CAUTION

To reduce the risk of **SERIOUS INJURY** or **DEATH**:
Disconnect power **BEFORE** performing **ANY** adjustments.

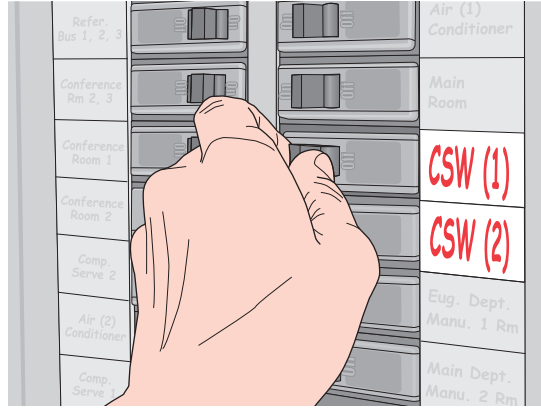

SET GATE OPENING DIRECTION

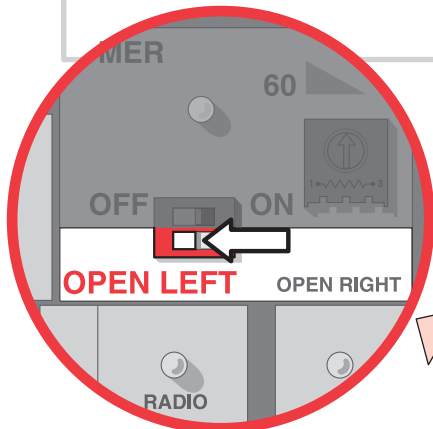
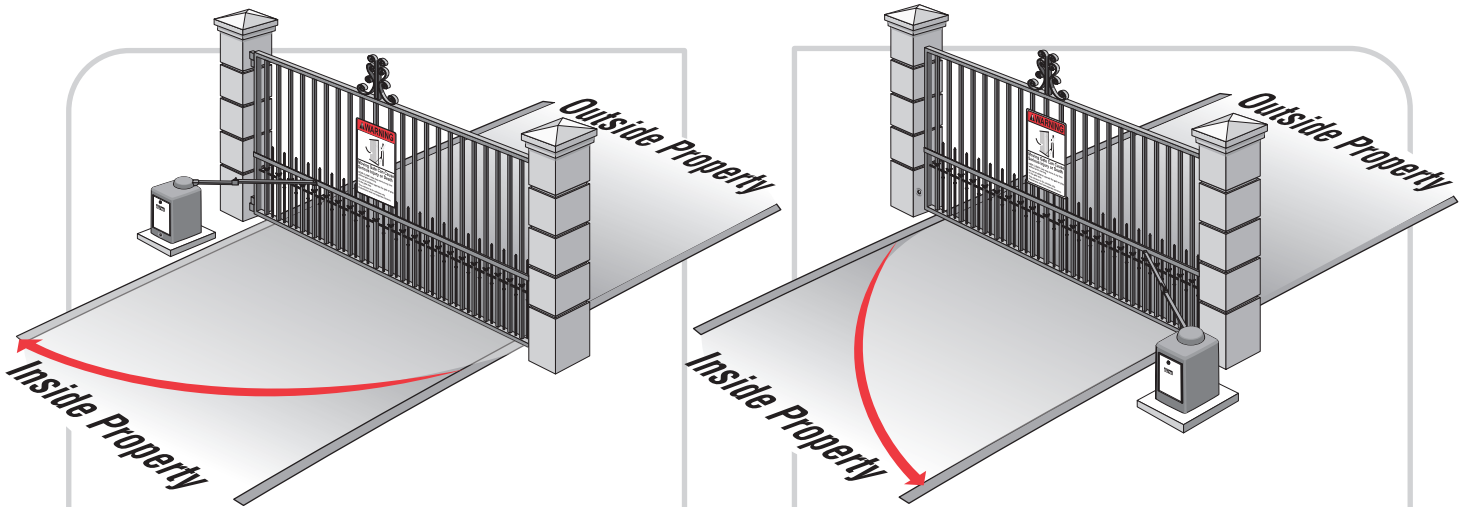

Open to the LEFT

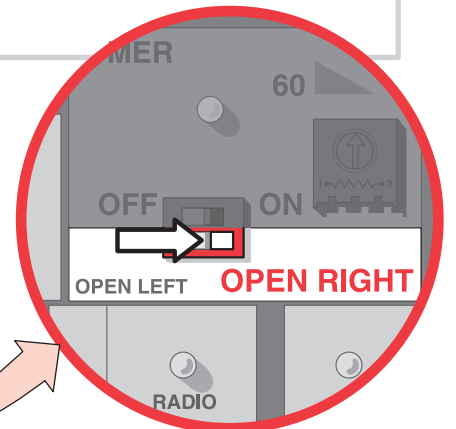
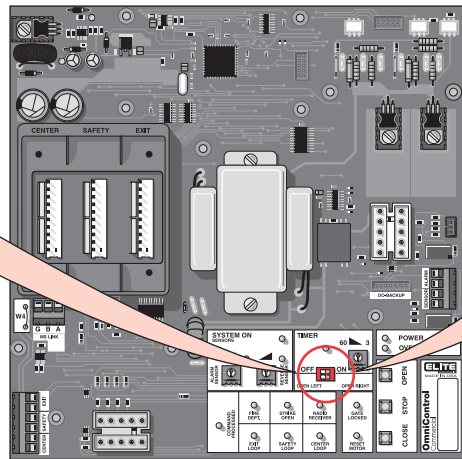

Open to the RIGHT

LIMIT SWITCH ADJUSTMENT

Release the red safety handle and move the gate to the open position. Loosen the screw on one of the limit cams and turn the cam until the half moon shape hits the limit switch and you hear the switch click. Tighten cam. Move gate to the closed position and do the same with the other limit cam. For a more precise adjustment, use the allen screw.

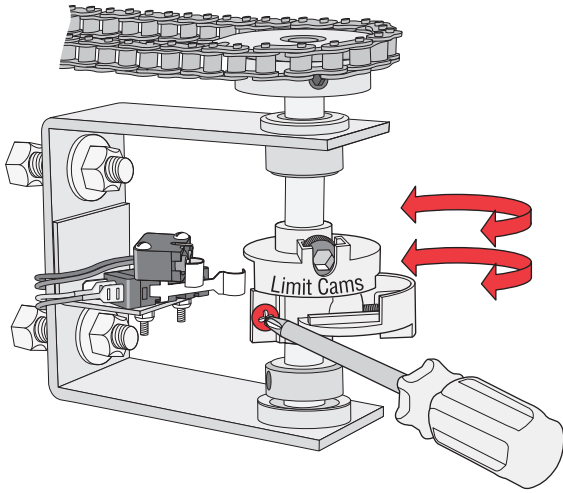

Loosen screws to turn limit cams.

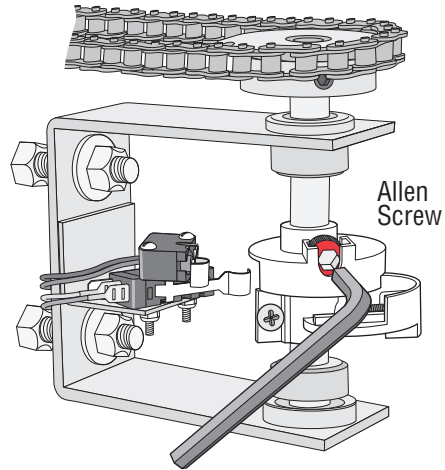

Precise adjustment.

CLUTCH ADJUSTMENT

The adjustment is for a gate that is over 300 pounds and 12 feet long or longer. While the gate is closing, instantly an “open” command is given as shown below; the clutch may slip a bit, max. of 1/4 to 3/4 of a turn (slippage depends on the weight of the gate). If it does not slip, then readjust the clutch.

Adjust the clutch with a wrench

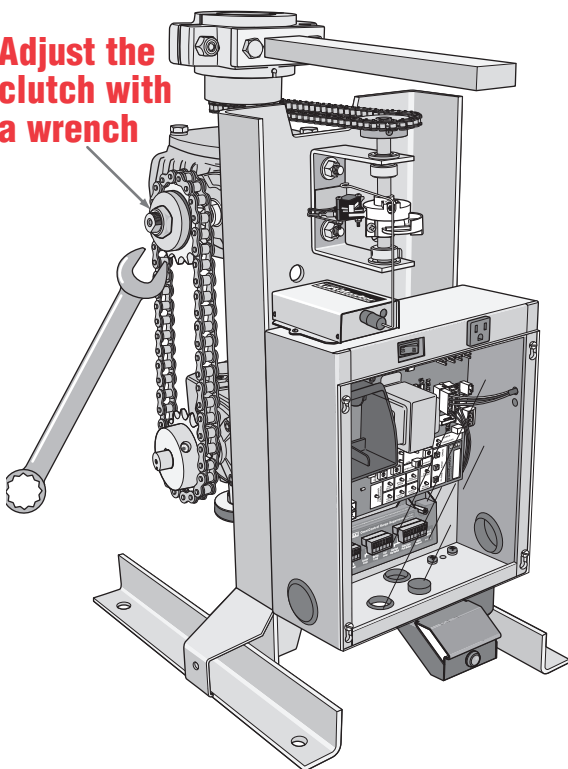

Gate is given an “Open” command before completing a normal close-cycle.

Gate smoothly reverses direction with the clutch slipping 1/4 to 3/4 turn.

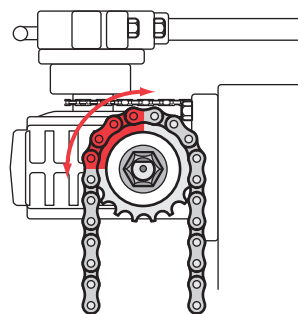
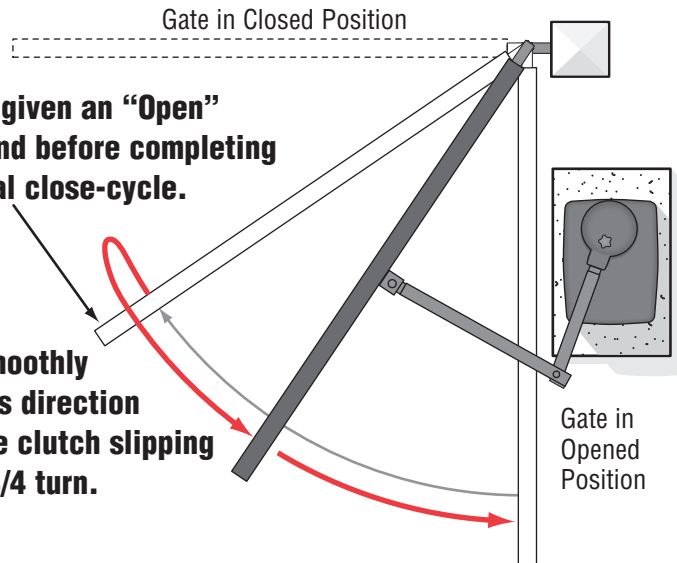

Typical clutch slippage (1/4 turn)

315 MHZ 24Vdc RADIO RECEIVER PROGRAMMING

Setting Security Mode (High) or (Normal):

The receiver is factory set at **HIGH** security mode. To verify, refer to the label next to jumper P4. (See illustration below.)

The Receiver can be used with up to **15** rolling code remotes or passwords in **HIGH** security mode. Alternately, it can be used with up to **31** of any type remote in **NORMAL** security mode, including any combination of rolling code, billion code, or dip switch remotes.

When changing from **NORMAL** to **HIGH** security mode, *all previous remote control codes must be erased*. See next page to erase and reprogram remote controls that are being used.

CAUTION

To **AVOID** damaging receiver, disconnect receiver's power **BEFORE** changing jumpers.

WARNING

To reduce the risk of **SERIOUS INJURY** or **DEATH** from a moving gate:

- **ALWAYS** keep remote controls out of reach of children. **NEVER** permit children to operate, or play with remote control.
- Activate gate **ONLY** when it can be seen clearly, is properly adjusted, and there are no obstructions in gate's path.
- **ALWAYS** keep gate in sight until completely closed. **NEVER** permit anyone to cross path of a moving gate.

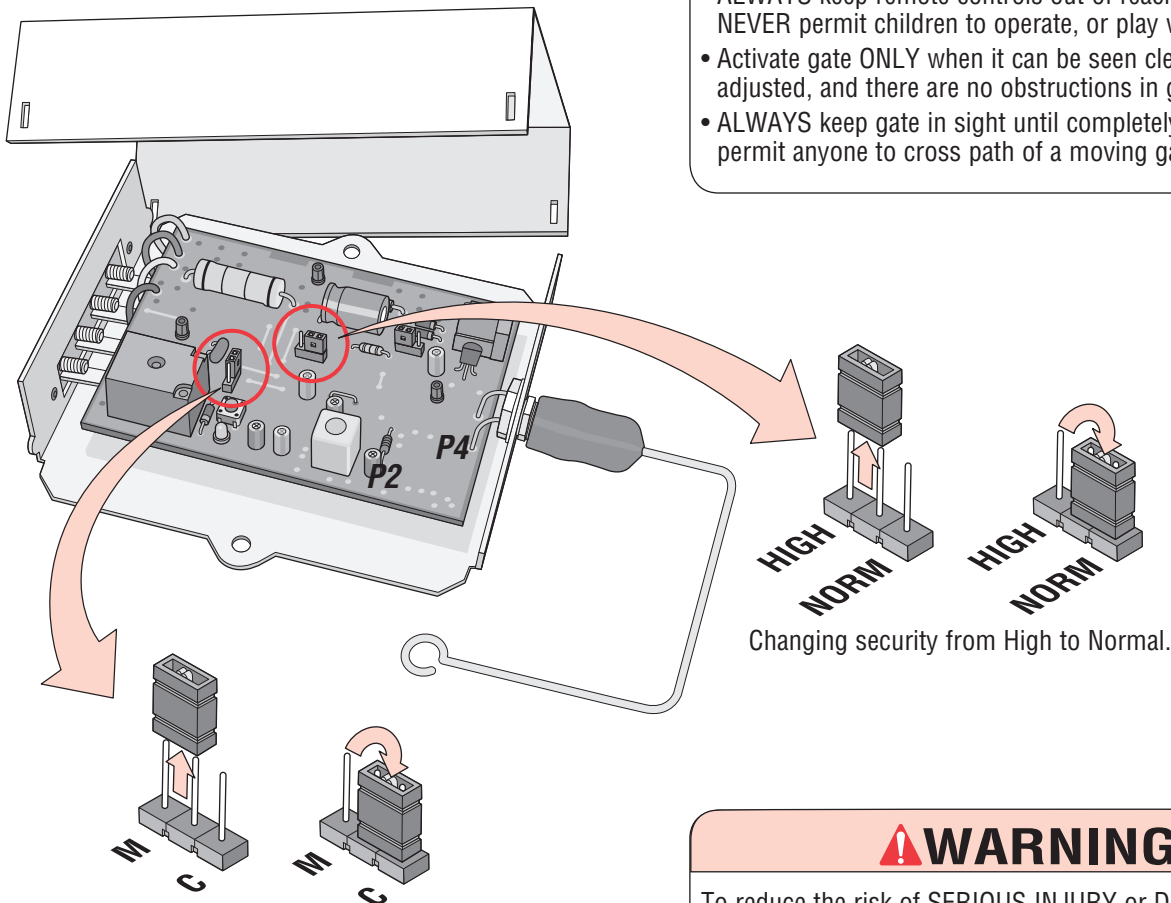

Changing security from High to Normal.

Changing output duration from Momentary to Constant.

Setting Output Duration (M) or (C):

The receiver is factory set at **(M)** Momentary. To verify, refer to the label next to jumper P2. (See illustration above.)

For commercial applications, the receiver can be set to either **(C)** constant or **(M)** momentary closure.

With the jumper in the **(M)** momentary position, the *contacts will close for 1/4 second regardless of the length of remote control transmission*.

With the jumper in **(C)** constant position, the *contacts will stay closed as long as the remote control continues transmitting*. Push and **HOLD** remote button to open or close gate.

WARNING

To reduce the risk of **SERIOUS INJURY** or **DEATH**, the use of **CONSTANT OPERATION** on residential operators is **PROHIBITED**.

315 MHz 24Vdc RADIO RECEIVER PROGRAMMING

IMPORTANT: Hand-held remote **NOT** included.

NOTICE: To comply with FCC and or Industry Canada (IC) rules, adjustment or modifications of this receiver and/or transmitter are prohibited, except for changing the code setting or replacing the battery. THERE ARE NO OTHER USER SERVICEABLE PARTS. Tested to Comply with FCC Standards FOR HOME OR OFFICE USE. Operation is subject to the following two conditions: (1) this device may not cause harmful interference, and (2) this device must accept any interference received, including interference that may cause undesired operation.

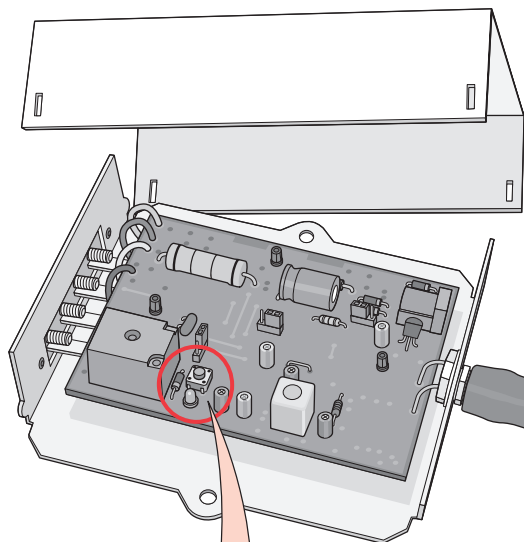

NOTE: Disconnect the second receiver when using a master/second setup.

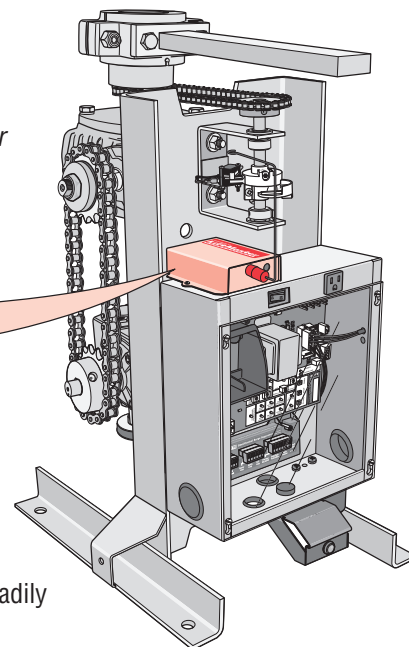

Programming Radio Receiver:

1. Press and release the “**Learn**” button on the receiver. The learn indicator light will glow steadily for 30 seconds.
2. Within 30 seconds, press and hold the button on the hand-held remote. The operator will now operate when the push button on the remote control is pressed. Repeat Steps 1 and 2 for each remote control that will be used.

Erase ALL Remote Control Codes:

Press and hold the “**Learn**” button on the receiver panel until the indicator light turns off (about 6 seconds). All previous codes are now erased. Reprogram each remote you wish to use.

Optional 315 MHz Hand Held Remotes - See Accessories

SETTING THE TIMER

Single Operator

To use the automatic close for the gate system the timer switch should be put in the "ON" position.

To use the push close command, the timer should be switched to the "OFF" position. Push button once to open gate, push button again to close gate.

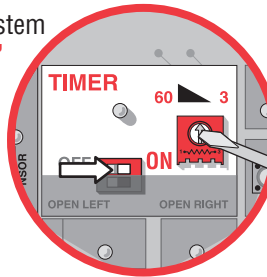

Set timer 3 to 60 seconds.

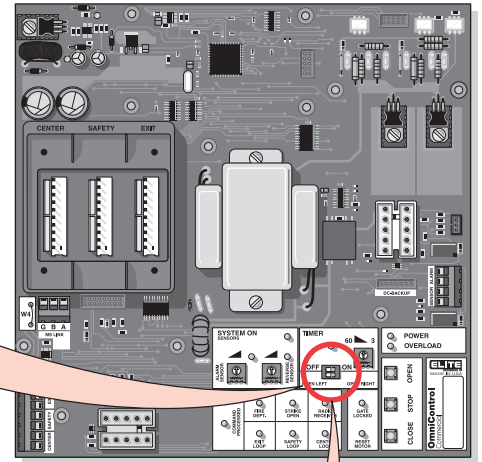
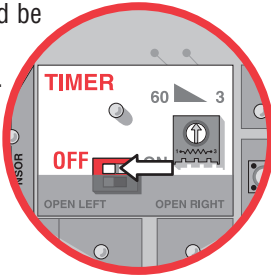

Master/Second Operators

Operators need to be connected by **M/S LINK**. See Linking Master page 19.

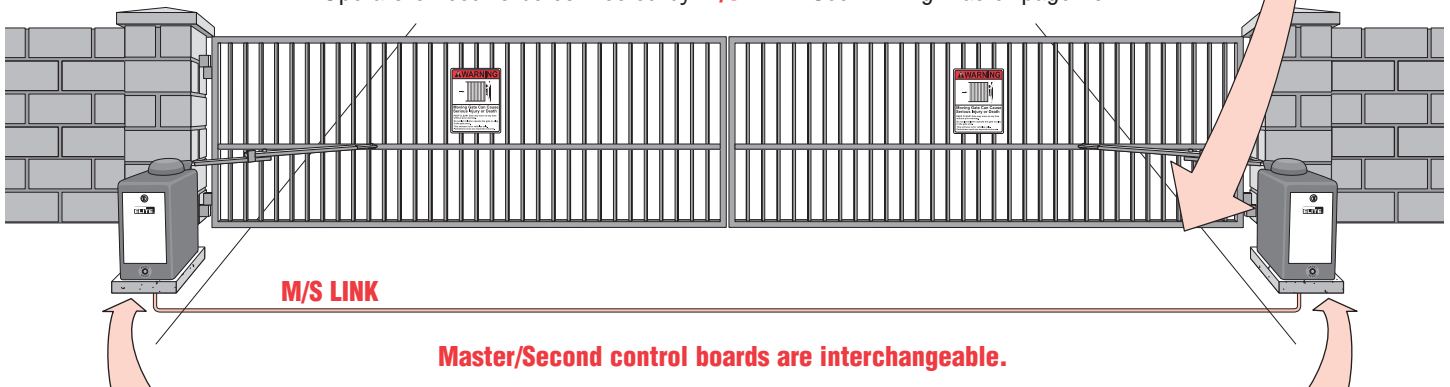

with Timers ON

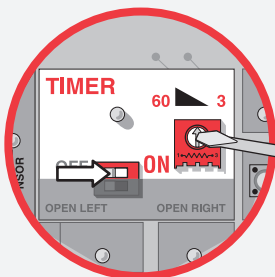

3. Use Timer on Master Board Only. (3 to 60 seconds)

1. Turn MASTER timer ON.
2. Turn SECOND timer OFF.

NOTE: If a secondary photoelectric sensor device is NOT used when the timer is ON, the gate WILL hit a vehicle obstructing the gate path before reversing during the close cycle.

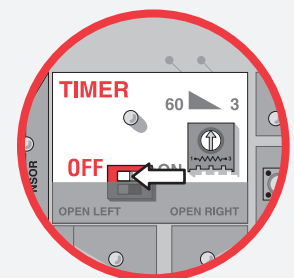

2. Turn Second Timer to Maximum Counterclockwise Setting.

Master Board

Second Board

with Timers OFF

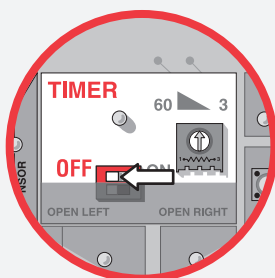

1. Turn BOTH timers OFF.

NOTE: Push button once to open gate, push button again to close gate.

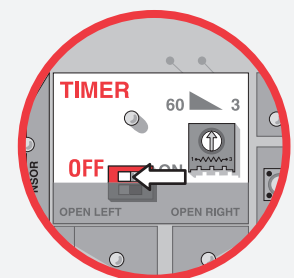

ADJUSTING REVERSING SENSOR(S)

Adjust the “**Reverse Sensor**” on the OmniControl™ board. **Alarm Sensor** does not need to be adjusted except where noted below.

The level of reverse sensitivity depends on the weight of the gate and the condition of installation.

Sensor is too sensitive = If the gate stops in midcycle or reverses by itself.

Sensor is not sensitive enough = If the gate hits an object and does not stop or reverse.

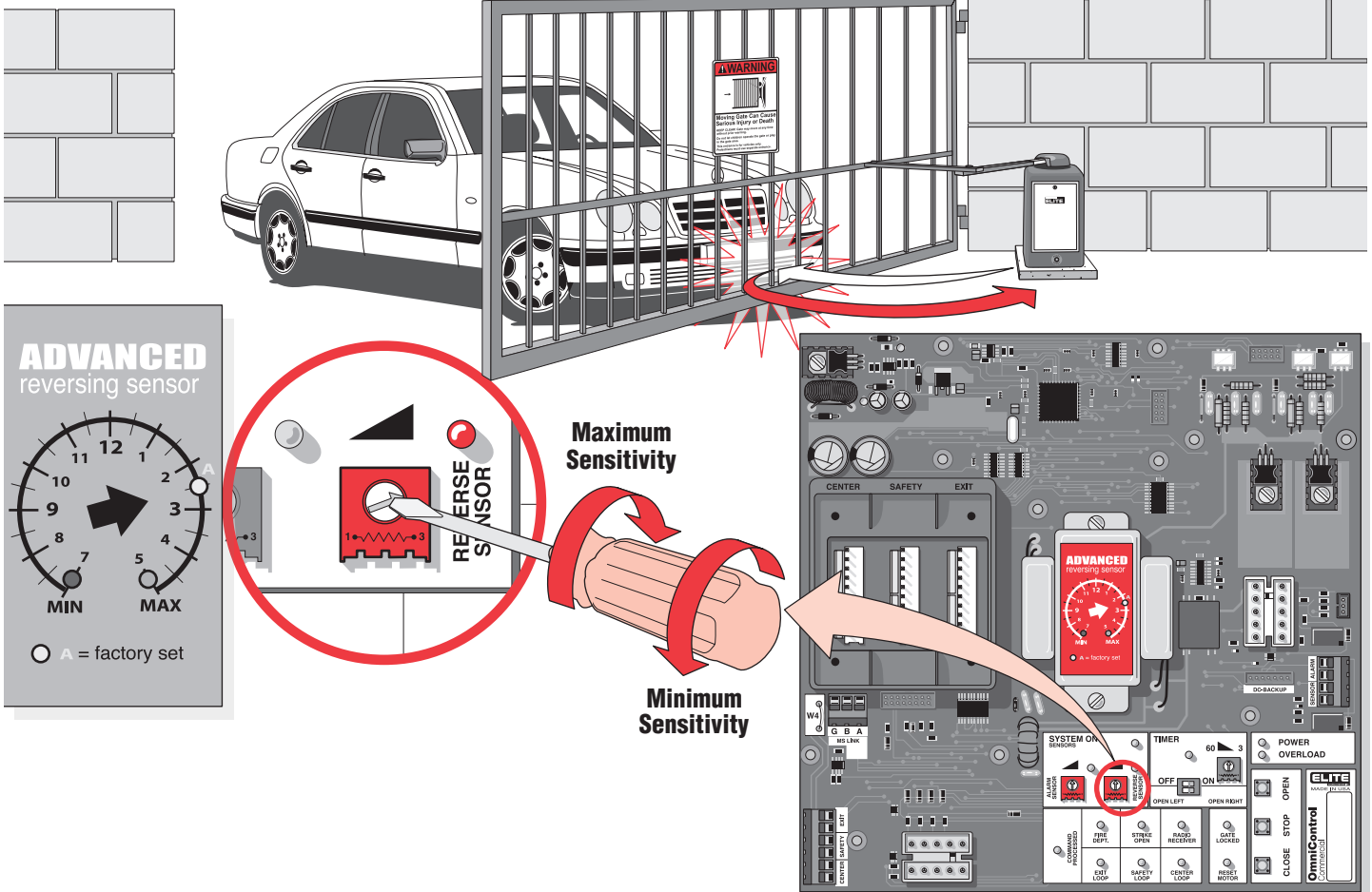

DC2000™ Reverse Sensor

The DC2000™ has a separate reverse sensor that will need to be adjusted. The 110Vac operator power needs to be turned off and the DC2000™ should have the “**Charge OK**” LED **ON** to make the adjustment.

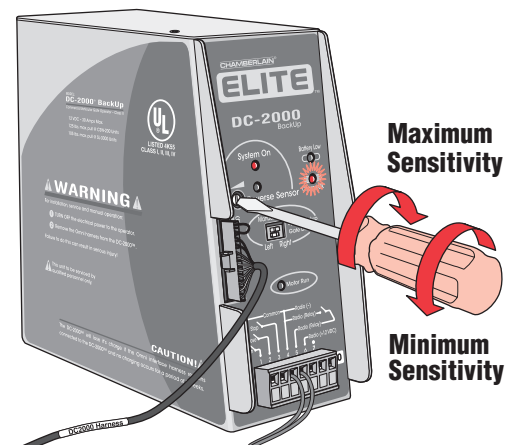

OMNI CONTROL™ BOARD CONNECTIONS

Purchased separately from Chamberlain Elite®.

NOTE: Refer to the OmniControl™ board manual for more specific information.

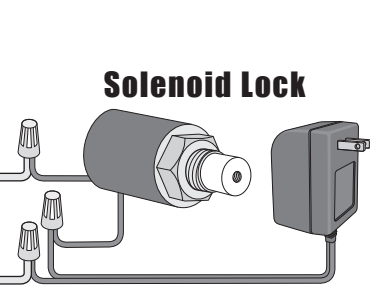
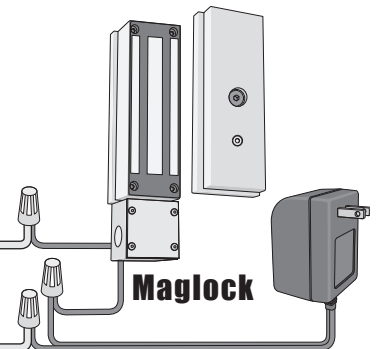
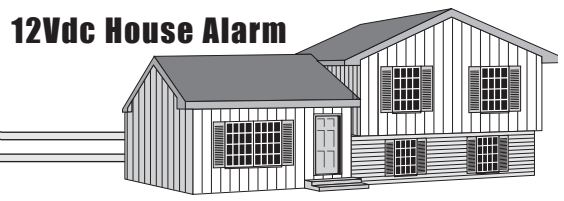
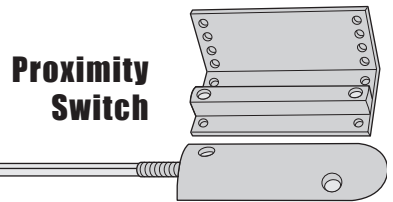
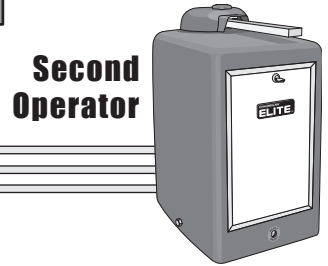
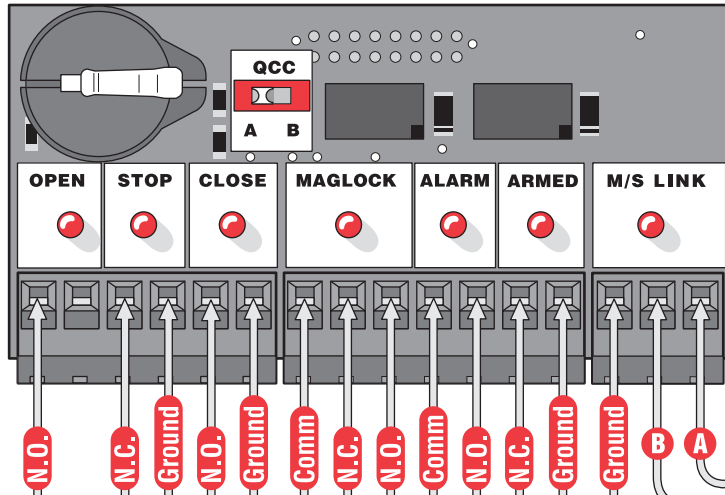
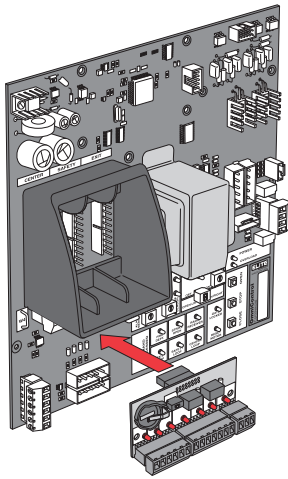

Relay Contact Rating
0.5 Amp - 125Vac
1 Amp - 24Vdc

3 Button Station
Dry Contact

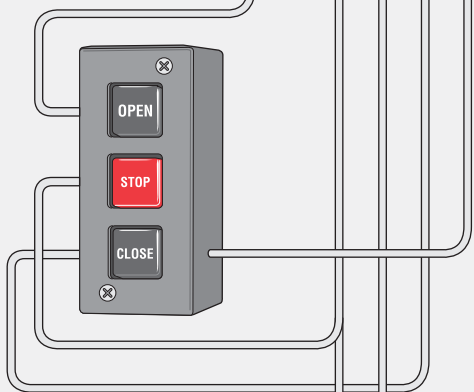

Stop Button
Dry Contact

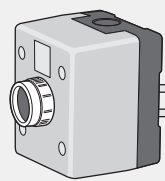

NOTE: Cut jumper W4 wire for 3 button station or stop button.

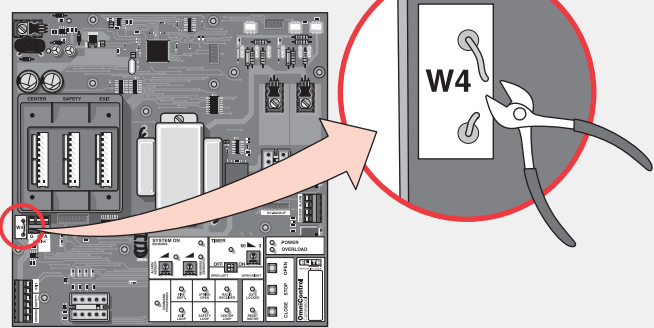

IMPORTANT SAFETY INSTRUCTIONS

WARNING

To reduce the risk of SEVERE INJURY or DEATH:

1. READ AND FOLLOW ALL INSTRUCTIONS.
2. NEVER let children operate or play with gate controls. Keep the remote control away from children.
3. ALWAYS keep people and objects away from the gate. NO ONE SHOULD CROSS THE PATH OF THE MOVING GATE.
4. Test the gate operator monthly. The gate MUST reverse on contact with a rigid object or stop when an object activates the non-contact sensors. After adjusting the force or the limit of travel, retest the gate operator. Failure to adjust and retest the gate operator properly can increase the risk of INJURY or DEATH.
5. Use the emergency release ONLY when the gate is not moving.
6. KEEP GATES PROPERLY MAINTAINED. Read the owner's manual. Have a qualified service person make repairs to gate hardware.
7. The entrance is for vehicles ONLY. Pedestrians MUST use separate entrance.
8. Disconnect ALL power BEFORE performing ANY maintenance.
9. ALL maintenance MUST be performed by a Chamberlain Elite professional.
10. **SAVE THESE INSTRUCTIONS.**

MAINTENANCE:

1. Disconnect power before servicing.
2. The gate area should be kept clean to insure proper operation.
3. Make sure the hinges are working smoothly and lubricated properly.
4. Make sure gate arm is greased properly.
5. Check gate reversing sensor. Check it monthly.
6. Check for proper synthetic oil level in the upper gear box (10W-30 weight synthetic oil).
7. Severe or high cycle usage will require more frequent maintenance checks.
8. Inspection and service should always be performed anytime a malfunction is observed or suspected.
9. When servicing, please do some "house cleaning" of the operator and the area around the operator. Pick up any debris in the area. Clean the operator as needed.
10. It is suggested that while at the site voltage readings be taken at the operator. Using a Digital Voltmeter, verify that the incoming voltage to the operator is within ten percent of the operators rating.

BUILT-IN RESET SWITCH

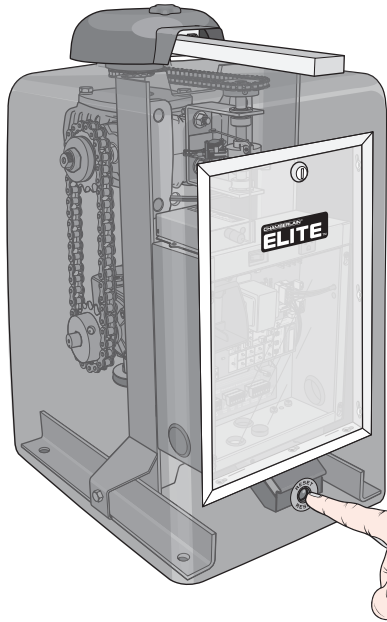

When the gate operator's audio alarm (see below) has been tripped, the reset switch must be pushed for the operator to function again.

The reset switch will shut off an activated audio alarm and reset the operator to function again.

If the audio alarm goes off, always check the gate area for:

- *Obstructions in the gate path.*
- *Damage to the gate and/or gate operator.*

Pressing the reset switch will stop a moving gate during a normal open/close cycle, like a stop button. The operator does **NOT** need to be reset after doing this.

AUDIO ALARM

The alarm could be tripped when one of the following happens *twice consecutively*, then the alarm will sound for **5 minutes or until the reset switch is pressed!**

Press the built-in reset switch to shut off alarm and reset operator (see above).

The operator arm or gate is incorrectly installed.

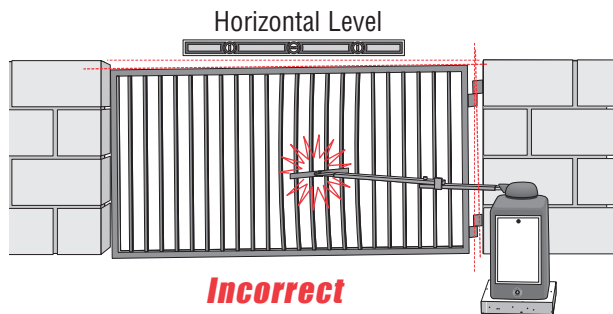

Vertical Level

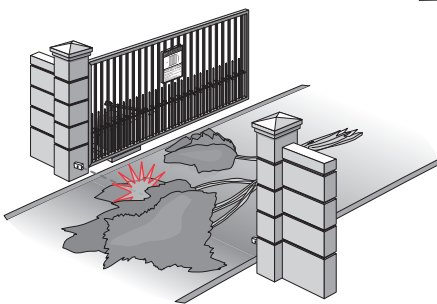
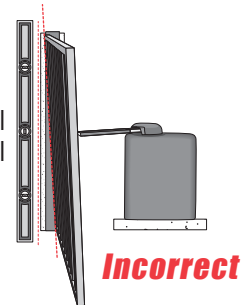

An externally wired photoelectric sensor has been triggered twice (photoelectric sensor blocked).

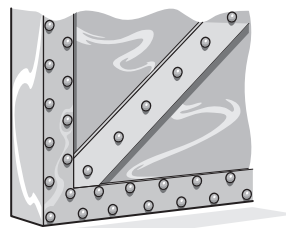

The gate is TOO heavy.



A foreign object is on the gate frame while the gate is moving.



The gate is moving and a car pushes the gate.



Gate hinges are too tight or broken and the gate is not moving freely.



The gate hits the driveway, curb or other, and gets stuck or bent in an awkward position.

EMERGENCY MANUAL RELEASE

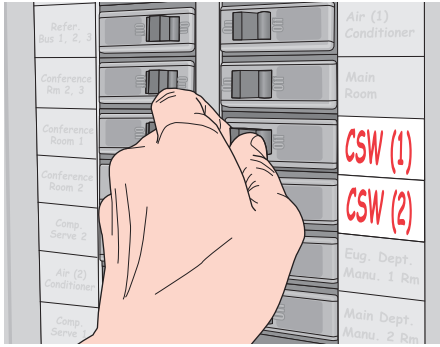

NOTE: Use the dedicated breaker switch to disconnect power to the operator.

- 1 Unscrew star knob.**
- 2 Lift off cover.**
- 3 Loosen red handle as shown.**
Gate can now be manually moved.

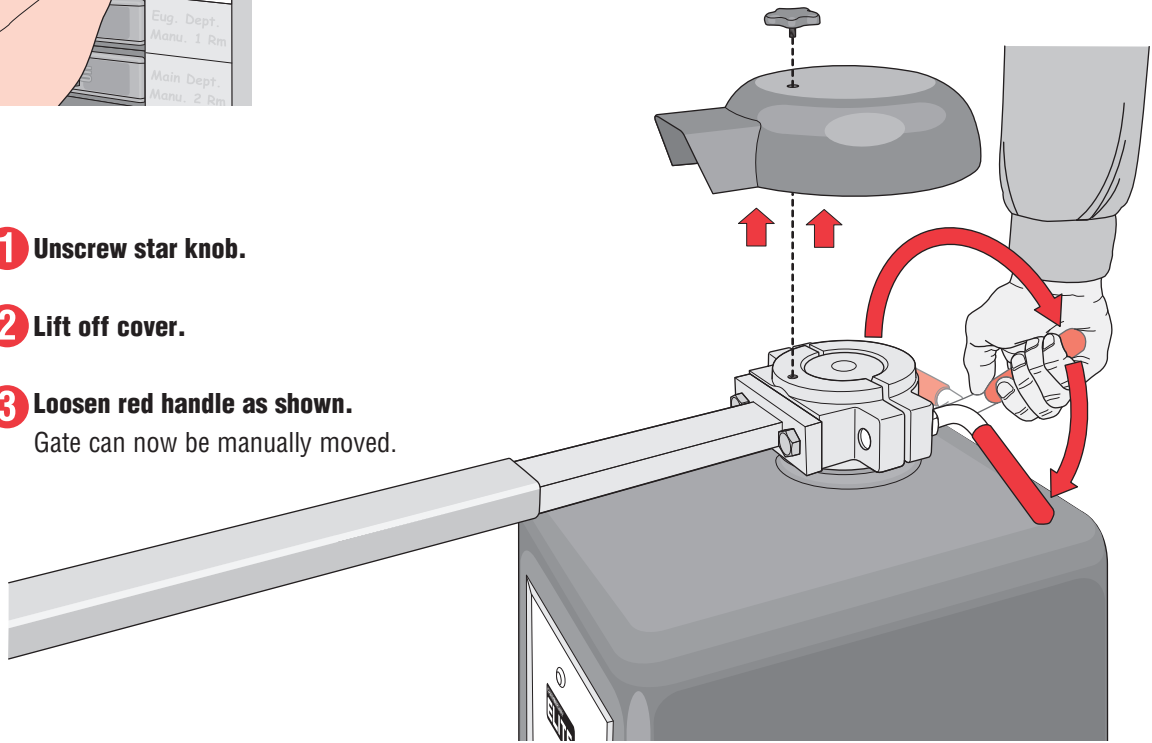

Grab the gate to move it.

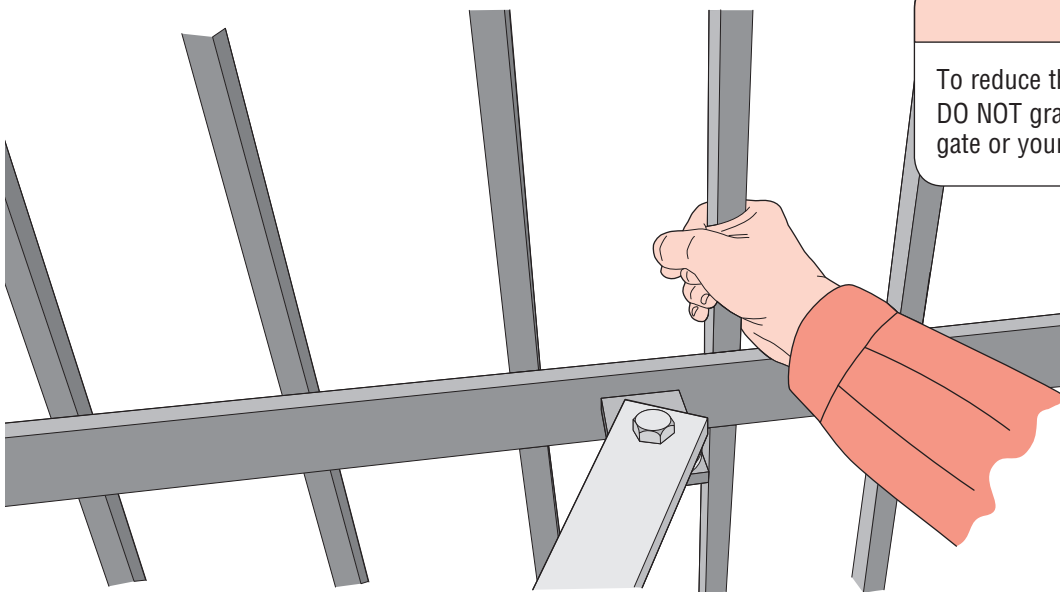

CAUTION

To reduce the risk of **SERIOUS INJURY**:
DO NOT grab the operator arm to move the gate or your fingers could get pinched.

Tighten the red handle, replace the cover and knob when finished.

When the power is on again, the gate will readjust itself automatically.

WIRING DIAGRAM • CSW200UL™ AND CSW200ULDM™

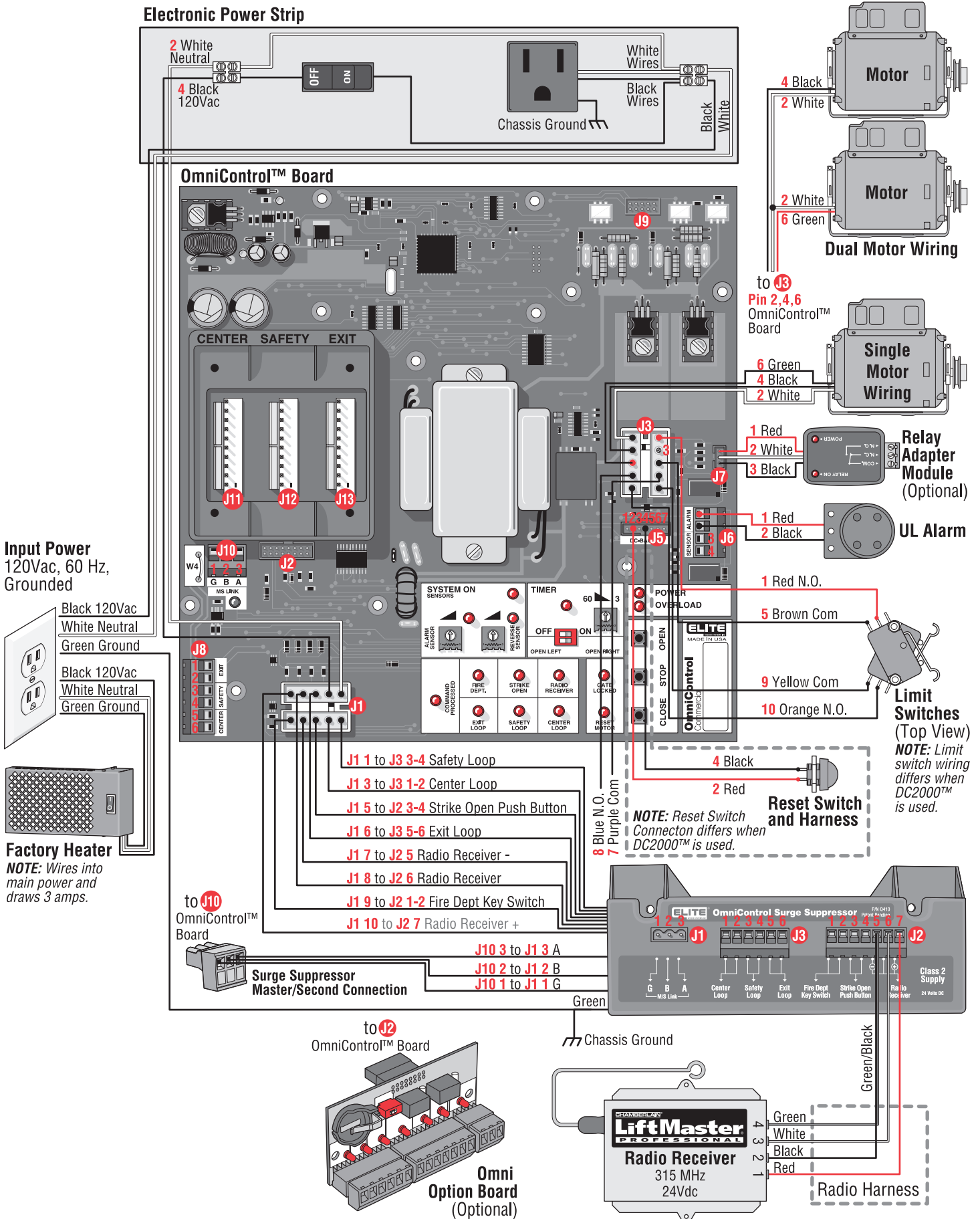

NOTE: See table on next page.

WIRING TABLE • CSW200UL™ AND CSW200ULDM™

<i>OmniControl™ Board</i>					
J #	J Pin #	Signal Type	Direction	Level (+/- 10%)	Input Connection
J1	1	Safety Loop	In	5 or 0Vdc	External Loop Detector Wires, 120Vac Power, Radio Receiver, Strike Open, Key Switch Harness
J1	2	Input Power Neutral	In	0V	
J1	3	Center Loop	In	5 or 0Vdc	
J1	4	Input Power 120Vac	In	120Vac	
J1	5	Strike Open	In	5 or 0Vdc	
J1	6	Exit Loop	In	5 or 0Vdc	
J1	7	Radio Receiver –	In	0V	
J1	8	Radio Receiver	In	0V	
J1	9	Fire Dept Key Switch	In	Dry	
J1	10	Radio Receiver +	Out	24Vdc	
J2	10 Pins	OmniControl™ Board	Out	24Vdc	OmniControl™ Board Input
J3	1	Limit Switch Red N.O.	Out	0Vdc	Motor(s), Limit Switches, Maglock/Solenoid Harness
J3	2	Motor White	Out	0V	
J3	3	Normally Closed (No Wire)	In	5 or 0Vdc	
J3	4	Motor Black	Out	120Vac	
J3	5	Limit Switch Brown Com	In	0V	
J3	6	Motor Green	Out	120Vac	
J3	7	Purple Com	In	0V	
J3	8	Blue N.O.	In	5 or 0Vdc	
J3	9	Limit Switch Yellow Com	In	0V	
J3	10	Limit Switch Orange N.O.	In	5 or 0Vdc	
J5	1	–	In	–	Reset Switch Input
J5	2	Reset Switch Red	In	Dry	
J5	3	–	In	–	
J5	4	Reset Switch Black	In	Dry	
J5	5	–	In	–	
J5	7	–	In	–	
J6	1	UL Alarm Red	Out	24Vdc	UL Alarm and Photoelectric Sensors
J6	2	UL Alarm Black	Out	0Vdc	
J6	3	Photoelectric Sensor	In	5 or 0Vdc	
J6	4	Photoelectric Sensor	In	0V	
J7	1	Relay Adapter Red	In	5 or 0Vdc	Relay Adapter Module Input
J7	2	Relay Adapter White	In	0Vdc	
J7	3	Relay Adapter Black	In	0Vdc	
J8	1	Plug-In Exit Loop Wire	In	2 to 10Vdc	Plug-In Loop Detector Wires
J8	2	Plug-In Exit Loop Wire	In	2 to 10Vdc	
J8	3	Plug-In Safety Loop Wire	In	2 to 10Vdc	
J8	4	Plug-In Safety Loop Wire	In	2 to 10Vdc	
J8	5	Plug-In Center Loop Wire	In	2 to 10Vdc	
J8	6	Plug-In Center Loop Wire	In	2 to 10Vdc	
J9	16 Pins	1 HP Board	–	–	Not Used
J10	1	G M/S Link	In/Out	0Vdc	Master/Second Link
J10	2	B M/S Link	In/Out	5 or 0Vdc	
J10	3	A M/S Link	In/Out	5 or 0Vdc	
J11	10 Pins	Center Loop Detector	In	5 or 0Vdc	Plug-In Loop Detector Inputs
J12	10 Pins	Safety Loop Detector	In	5 or 0Vdc	
J13	10 Pins	Exit Loop Detector	In	5 or 0Vdc	

<i>OmniControl™ Surge Suppressor</i>					
J1	1	G M/S Link (G)	In/Out	0V	Master/Second Link Input
J1	2	B M/S Link (B)	In/Out	5 or 0Vdc	
J1	3	A M/S Link (A)	In/Out	5 or 0Vdc	
J2	1	Fire Dept. Key Switch (7)	In	Dry	Radio Receiver, Strike Open Push Button, Fire Dept Key Switch Inputs
J2	2	Fire Dept. Key Switch (8)	In	Dry	
J2	3	Strike Open Push Button (9)	In	5 or 0Vdc	
J2	4	Strike Open Push Button (10)	In	0V	
J2	5	Radio Receiver – (11)	In	0V	
J2	6	Radio Receiver (12)	In	5 or 0Vdc	
J2	7	Radio Receiver + (13)	Out	24Vdc	
J3	1	Center External Loop Detector (1)	In	2 to 10Vdc	External Loop Detector Center, Safety, Exit Wires Input
J3	2	Center External Loop Detector (2)	In	2 to 10Vdc	
J3	3	Safety External Loop Detector (3)	In	2 to 10Vdc	
J3	4	Safety External Loop Detector (4)	In	2 to 10Vdc	
J3	5	Exit External Loop Detector (5)	In	2 to 10Vdc	
J3	6	Exit External Loop Detector (6)	In	2 to 10Vdc	

WIRING DIAGRAM • CSW200UL1HP™

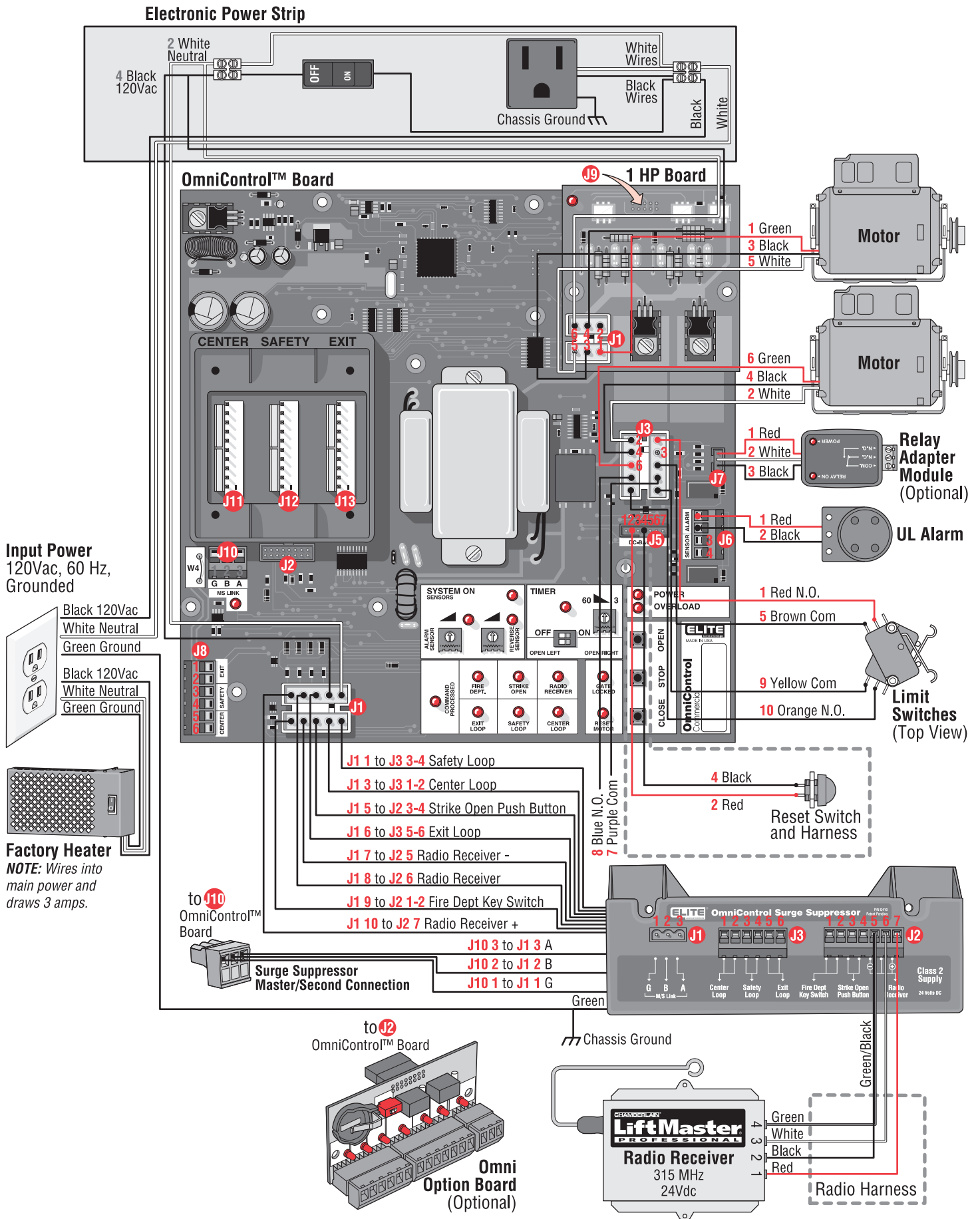

NOTE: See table on next page.

WIRING TABLE • CSW200UL1HP™

<i>OmniControl™ Board</i>					
J #	J Pin #	Signal Type	Direction	Level (+/- 10%)	Input Connection
J1	1	Safety Loop	In	5 or 0Vdc	External Loop Detector Wires, 120Vac Power, Radio Receiver, Strike Open, Key Switch Harness
J1	2	Input Power Neutral	In	0V	
J1	3	Center Loop	In	5 or 0Vdc	
J1	4	Input Power 120Vac	In	120Vac	
J1	5	Strike Open	In	5 or 0Vdc	
J1	6	Exit Loop	In	5 or 0Vdc	
J1	7	Radio Receiver –	In	0V	
J1	8	Radio Receiver	In	0V	
J1	9	Fire Dept Key Switch	In	Dry	
J1	10	Radio Receiver +	Out	24Vdc	
J2	10 Pins	OmniControl™ Board	Out	24Vdc	OmniControl™ Board Input
J3	1	Limit Switch Red N.O.	Out	0Vdc	Limit Switches, Maglock/Solenoid Harness
J3	2	Motor White	Out	0V	
J3	3	Normally Closed (No Wire)	In	5 or 0Vdc	
J3	4	Motor Black	Out	120Vac	
J3	5	Limit Switch Brown Com	In	0V	
J3	6	Motor Green	Out	120Vac	
J3	7	Purple Com	In	0V	
J3	8	Blue N.O.	In	5 or 0Vdc	
J3	9	Limit Switch Yellow Com	In	0V	
J3	10	Limit Switch Orange N.O.	In	5 or 0Vdc	
J5	1	–	In	–	Reset Switch Input
J5	2	Reset Switch Red	In	Dry	
J5	3	–	In	–	
J5	4	Reset Switch Black	In	Dry	
J5	5	–	In	–	
J5	6	–	In	–	
J5	7	–	In	–	
J6	1	UL Alarm Red	Out	24Vdc	UL Alarm and Photoelectric Sensors
J6	2	UL Alarm Black	Out	0V	
J6	3	Photoelectric Sensor	In	5 or 0Vdc	
J6	4	Photoelectric Sensor	In	0V	
J7	1	Relay Adapter Red	In	5 or 0Vdc	Relay Adapter Module Input
J7	2	Relay Adapter White	In	0V	
J7	3	Relay Adapter Black	In	0V	
J8	1	Plug-In Exit Loop Wire	In	2 to 10Vdc	Plug-In Loop Detector Wires
J8	2	Plug-In Exit Loop Wire	In	2 to 10Vdc	
J8	3	Plug-In Safety Loop Wire	In	2 to 10Vdc	
J8	4	Plug-In Safety Loop Wire	In	2 to 10Vdc	
J8	5	Plug-In Center Loop Wire	In	2 to 10Vdc	
J8	6	Plug-In Center Loop Wire	In	2 to 10Vdc	
J9	16 Pins	1 HP Board	Out	5 or 0Vdc	1 HP Motors Board
J10	1	G M/S Link	In/Out	0V	Master/Second Link
J10	2	B M/S Link	In/Out	5 or 0Vdc	
J10	3	A M/S Link	In/Out	5 or 0Vdc	
J11	10 Pins	Center Loop Detector	In	5 or 0Vdc	Plug-In Loop Detector Inputs
J12	10 Pins	Safety Loop Detector	In	5 or 0Vdc	
J13	10 Pins	Exit Loop Detector	In	5 or 0Vdc	
<i>1 HP Board</i>					
J1	1	Motor Green	Out	120Vac	2 Motors Output
J1	2	–	–	–	
J1	3	Motor Black	Out	120Vac	
J1	4	Input Power Black	In	120Vac	
J1	5	Motor White	Out	0V	
J1	6	Input Power White	In	0V	
<i>OmniControl™ Surge Suppressor</i>					
J1	1	G M/S Link (G)	In/Out	0V	Master/Second Link Input
J1	2	B M/S Link (B)	In/Out	5 or 0Vdc	
J1	3	A M/S Link (A)	In/Out	5 or 0Vdc	
J2	1	Fire Dept. Key Switch (7)	In	Dry	Radio Receiver, Strike Open Push Button, Fire Dept Key Switch Inputs
J2	2	Fire Dept. Key Switch (8)	In	Dry	
J2	3	Strike Open Push Button (9)	In	5 or 0Vdc	
J2	4	Strike Open Push Button (10)	In	0V	
J2	5	Radio Receiver – (11)	In	0V	
J2	6	Radio Receiver (12)	In	5 or 0Vdc	
J2	7	Radio Receiver + (13)	Out	24Vdc	
J3	1	Center External Loop Detector (1)	In	2 to 10Vdc	External Loop Detector Center, Safety, Exit Wires Input
J3	2	Center External Loop Detector (2)	In	2 to 10Vdc	
J3	3	Safety External Loop Detector (3)	In	2 to 10Vdc	
J3	4	Safety External Loop Detector (4)	In	2 to 10Vdc	
J3	5	Exit External Loop Detector (5)	In	2 to 10Vdc	
J3	6	Exit External Loop Detector (6)	In	2 to 10Vdc	

WIRING DIAGRAM • DC2000™ FOR SINGLE AND DM

NOTE: This diagram **only** shows the DC2000™ wiring and all other wiring not shown is the same as the diagram on page 37.

The 1 HP models **Can Not** have the DC2000™ battery backup system.

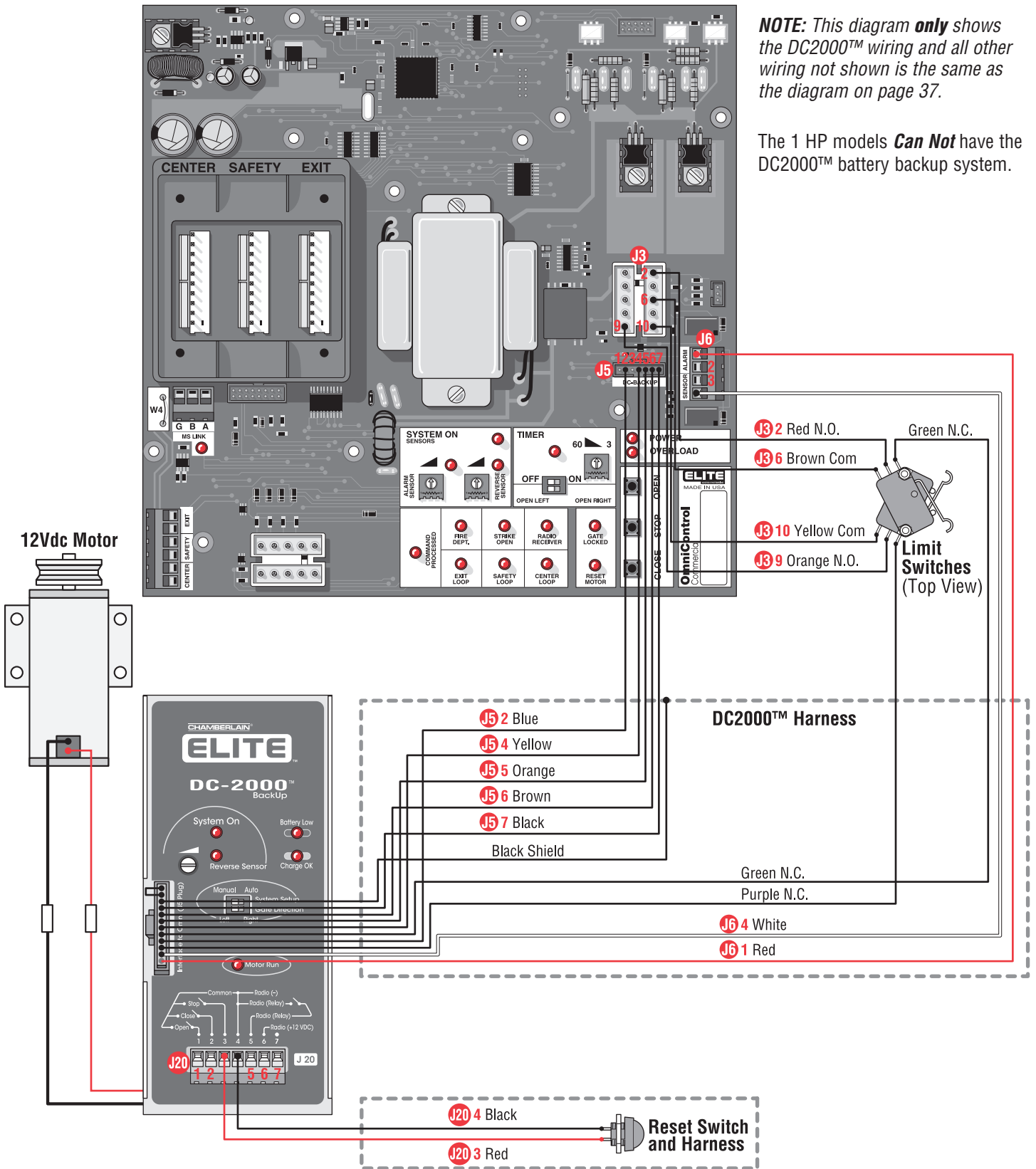

WIRING TABLE • DC2000™

J #	J Pin #	Signal Type	Direction	Level (+/- 10%)	Input Connection
J20	1	Open N.O.	Out	5 or 0Vdc	• Manual Three Button (Dry) Reset Switch
J20	2	Closed N.O.	Out	5 or 0Vdc	
J20	3	Stop N.O. Reset Switch	Out	5 or 0Vdc	
J20	4	Common Radio – Radio Relay Reset Switch	Out	0V	• Manual One Button (Dry) • Key Switch (Dry) • Radio Receiver • Reset Switch
J20	5	One Button Key Switch Radio Relay	Out	0V	• Manual One Button (Dry) • Key Switch (Dry) • Radio Receiver
J20	6	Radio + 12Vdc Photoelectric Sensor + 12Vdc	Out	12 or 0Vdc	• Radio Receiver 12Vdc • Photoelectric Sensor 12Vdc
J20	7	–	–	–	–

NOTE: All devices wired to the DC2000™ MUST be **dedicated** to it alone. Normal operation will be controlled by **separate** devices wired to the OmniControl™ board and surge suppressor.

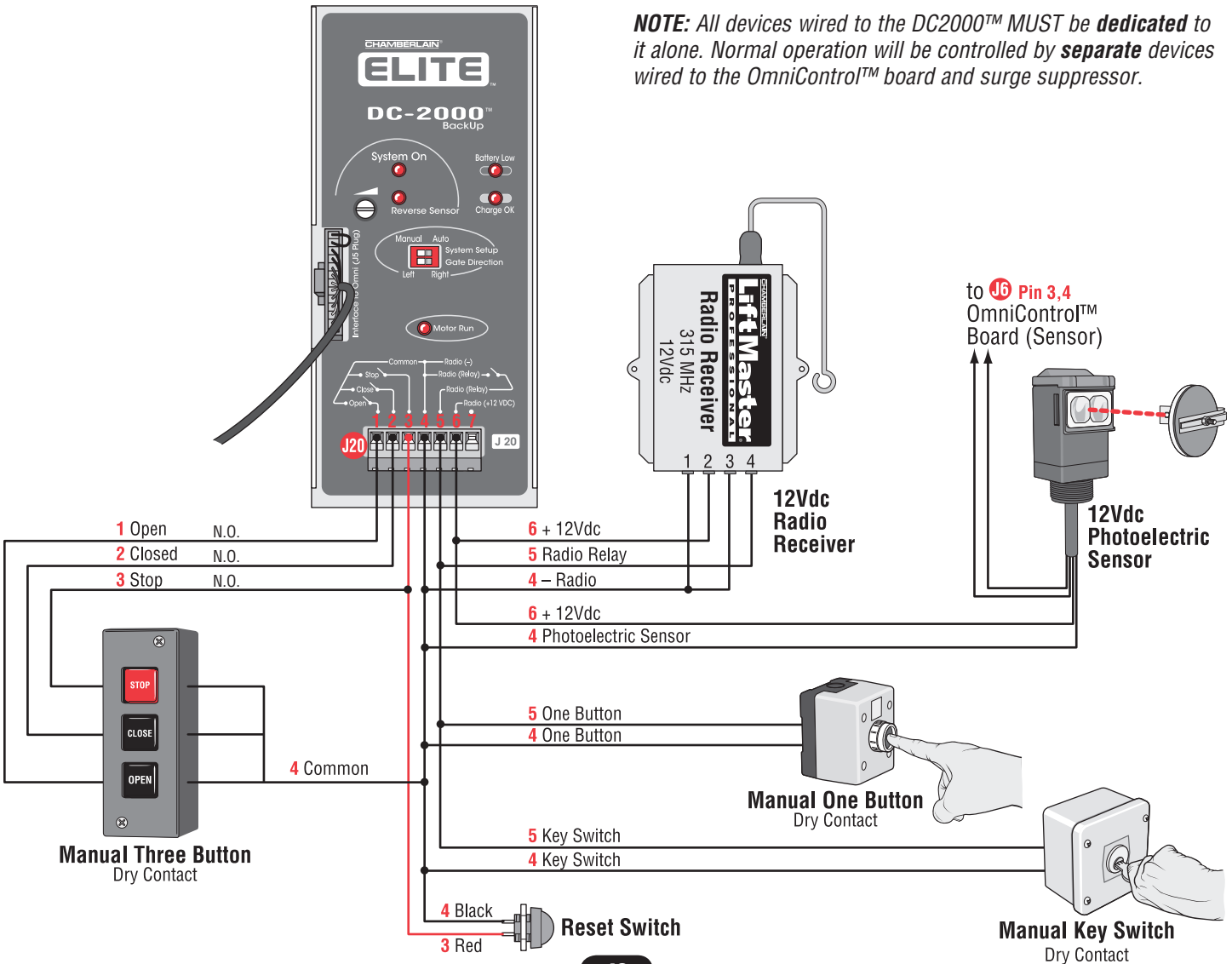

Troubleshooting

The Gate Will Not Operate with Remote: The radio receiver LED on the control board remains “ON” when using the remote control.

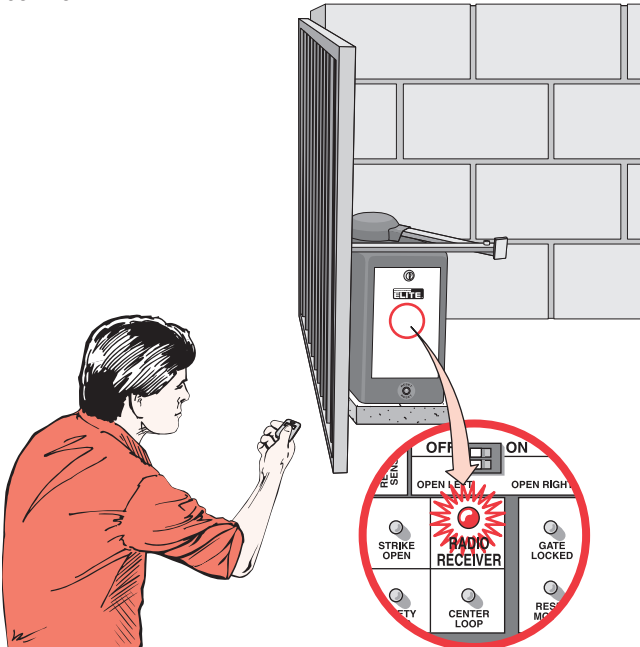

- Probable Cause:** Stuck remote control button.
Solution: Unstick remote control button.
- Probable Cause:** The radio receiver has malfunctioned in the “ON” position.
Solution: Cycle the power to the radio receiver.

The Gate Will Not Operate with Remote: The radio receiver LED on the control board remains “OFF” when using the remote control.

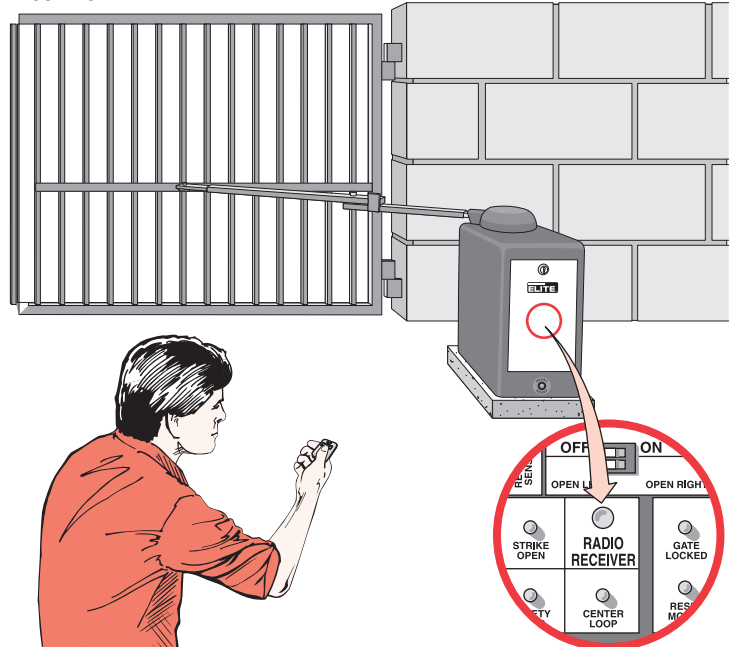

- Probable Cause:** Remote control battery is dead.
Solution: Replace remote control battery.
- Probable Cause:** The radio receiver has malfunctioned in the “OFF” position.
Solution: Cycle the power to the radio receiver. Remote control will need to be reprogrammed, see page 30.
- Probable Cause:** Radio receiver’s signal is not getting to gate operator.
Solution: Check wiring between receiver and surge suppressor.
- Probable Cause:** Remote is not programmed correctly.
Solution: Reprogram remote control, see page 30.
- Probable Cause:** Remote is not on the same frequency as the radio receiver.
Solution: Verify that remote control frequency is 315 MHz.
- Probable Cause:** Blown surge suppressor.
Solution: Measure the resistance between pin 12 and 13 on the surge suppressor (see page 16), if the circuit “closes” when the radio receiver is transmitting, replace the surge suppressor.

Resetting Motor(s)

NOTE: Press firmly to reset thermal breaker button(s).

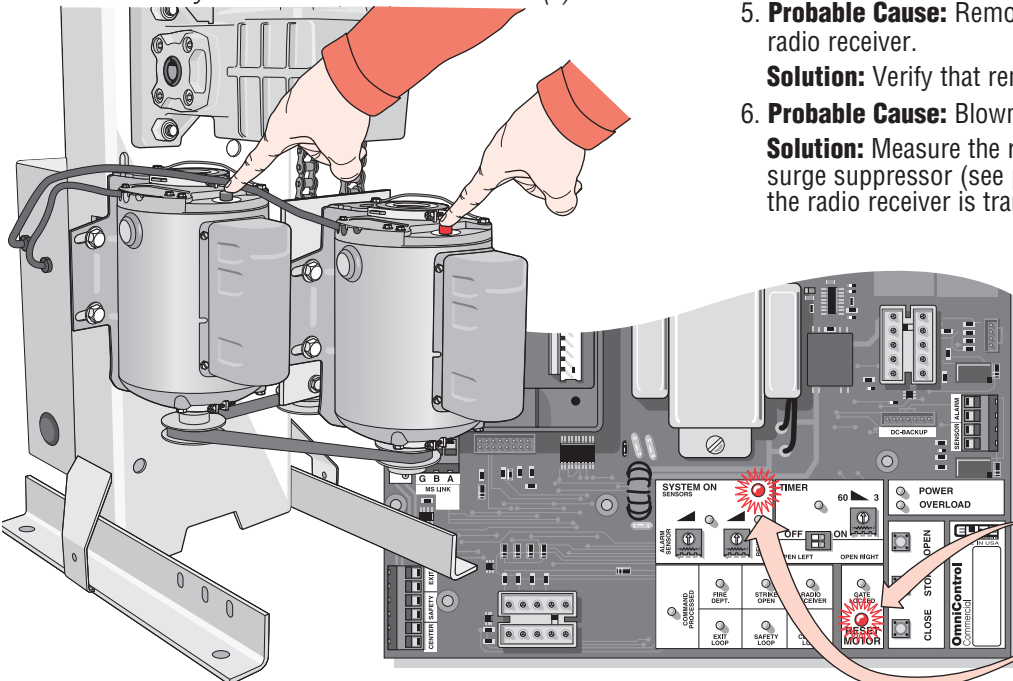

Motor(s) need resetting when:

Reset Motor LED light flashes once,
System ON LED light flashes rapidly.

TROUBLESHOOTING (CONTINUED)

<i>Condition</i>	<i>Probable Causes</i>	<i>Solution</i>
Overload LED ON and Power LED OFF	<ol style="list-style-type: none"> Short circuit at terminals 11 and 13. Short circuit at any of the loop detectors in the board. Short circuit in the control board. 	<ol style="list-style-type: none"> Remove the short circuit condition at the terminals. Remove the defective loop detector. Send the board to repair.
Overload LED ON and Power LED ON	<ol style="list-style-type: none"> Excessive current draw at terminal 13. Over-voltage at the 110 Vac line input. 	<ol style="list-style-type: none"> Reduce the accessories load from surge suppressor terminal 13. Verify your electrical power.
System On LED Flashing	<ol style="list-style-type: none"> Motor thermal fuse has popped-out (Rapid Flashing). One limit switch is faulty (Rapid Flashing). 	<ol style="list-style-type: none"> Reset the motor. OR Test the limit switches and wire connections, fix the fault.
Reverse Sensor LED ON	<ol style="list-style-type: none"> Gate has encountered an obstruction during traveling. Reverse sensor is extra sensitive. 	<ol style="list-style-type: none"> Remove the obstruction. Turn the reverse sensor switch counter-clockwise a little more and try again.
Alarm Sensor LED ON	<ol style="list-style-type: none"> Gate encountered an obstruction during traveling. Alarm sensor is extra sensitive. 	<ol style="list-style-type: none"> Remove the obstruction. Turn the alarm sensor switch counter clockwise a little more and try again.
Command Processed LED ON	<ol style="list-style-type: none"> There is a command hold active. 	<ol style="list-style-type: none"> This is a normal response of the gate operator. It does not represent necessarily that there is a problem.
Timer LED Blinking and Command Processed LED Blinking	<ol style="list-style-type: none"> There is a command holding the gate open. 	<ol style="list-style-type: none"> This is a normal response of the gate operator. It does not represent necessarily that there is a problem. Check inputs for command.
Timer LED Blinking, Command Processed LED Blinking and Reverse Sensor LED ON	<ol style="list-style-type: none"> Gate has reopened because it encountered an obstruction while closing. 	<ol style="list-style-type: none"> Any re-new command will resume normal operation. Check for obstructions.
Audio Alarm ON	<ol style="list-style-type: none"> Gate has encountered two consecutive obstructions while trying to close or open. 	<ol style="list-style-type: none"> Any re-new command will resume normal operation but not a radio command. Check for obstructions. You can stop the alarm by using the built-in reset button. You can stop the alarm by using an optional stop button.
Any Loop LED ON and No vehicle on the sensing area	<ol style="list-style-type: none"> The loop detector needs to be reset. The wire loop has been disrupted. The loop detector needs to work in a different frequency. The loop detector is too sensitive. 	<ol style="list-style-type: none"> Reset the loop detector (If you use Elite® Plug-in Loop detectors, change the setting for sensitivity and come back to your original setting.) Verify and correct connections. Set a different working frequency. Decrease the sensitivity of the loop detector.

Repair Parts

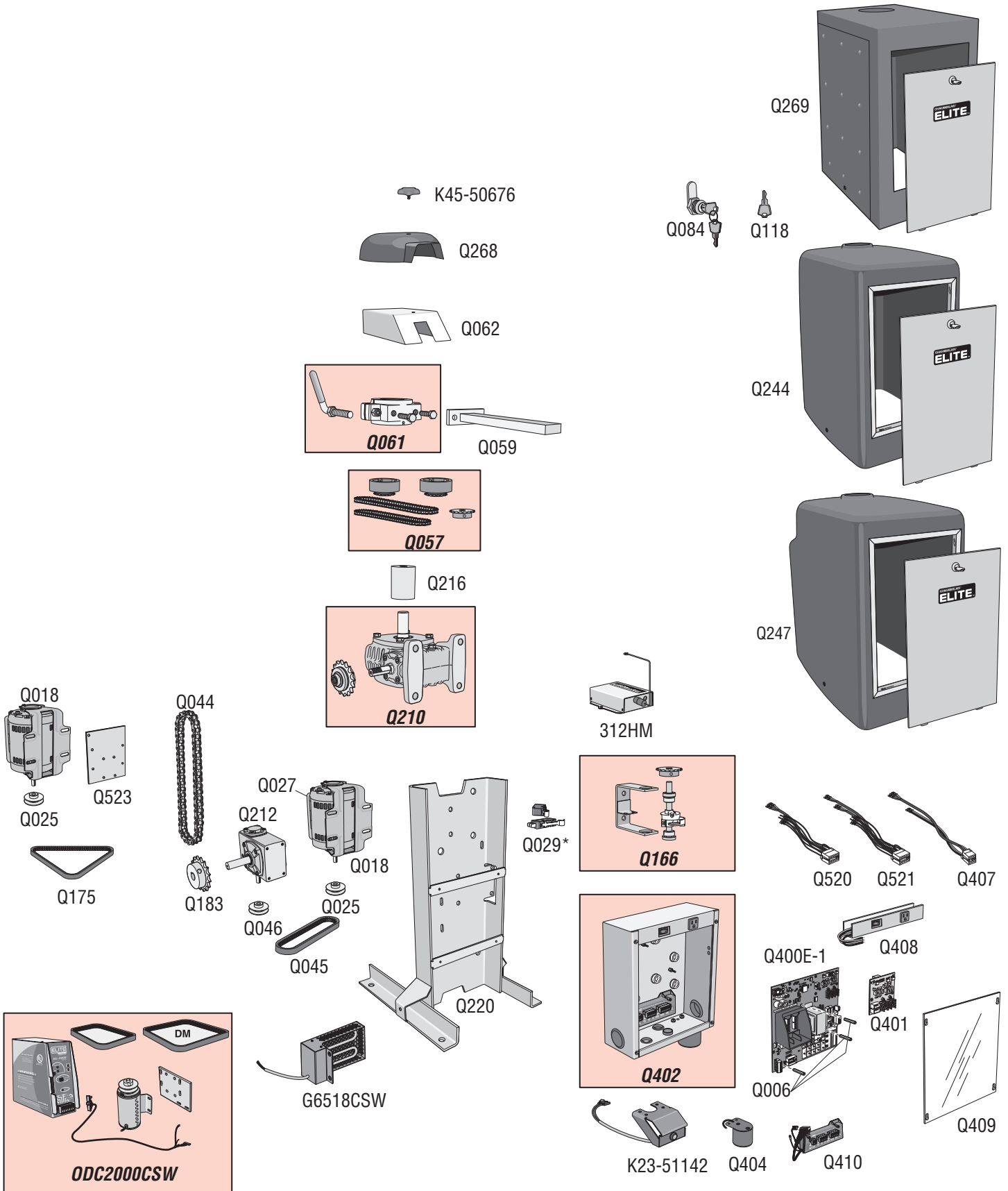

NOTE: * Sold individually, 2 shown.
For part list, refer to next page.

HOW TO ORDER REPAIR PARTS

OUR LARGE SERVICE ORGANIZATION SPANS AMERICA. INSTALLATION AND SERVICE INFORMATION IS AS NEAR AS YOUR TELEPHONE. SIMPLY DIAL OUR TOLL FREE NUMBER:

1-800-528-2806

www.chamberlain.com

WHEN ORDERING REPAIR PARTS, ALWAYS GIVE THE FOLLOWING INFORMATION:

- PART NUMBER
- PART NAME
- MODEL NUMBER

Address orders to:

THE CHAMBERLAIN GROUP, INC.
Technical Support Group
6050 S. Country Club Road
Tucson, Arizona 85706

REPAIR PART NAMES AND NUMBERS

Cludge Assembly - Q061

- Arm Release Handle
- Output Shaft Cludge

Sprocket and Chain Kit - Q057

- 1-1/8 inch dia. sprocket fits size 70 gear box
- 1 inch dia. sprocket fits size 60 gear box
- Sprocket #35
- Chain #35-72 links
- Chain #35-68 links

Assembly, limit Rack, CSW - Q165

- Limit Switch Bracket
- Limit Cam (Plastic Part)

Gear Box Assembly (Size 70) - Q210

- Sprocket

Electronic Box Assembly - Q402

- Electronic Metal Box
- Surge Suppressor
- Audio Alarm

Power Back-Up Unit - ODC2000CSW

- Drive Belt DC CSW (DM)
- Back-Up Motor DC 12V
- Chassis DC Back-Up
- Hardware Kit for DC Back-Up
- Drive Belt DC CW 4L240
- Wire Harness DC-2000
- Pulley DC1000 1/2 ID

- 312HM - 24V Radio Receiver
- G6518CSW - Heater
- K45-50676 - Star Knob
- K23-51142 - Reset Button Assembly
- Q006 - PC Board Nuts (Set)
- Q018 - 1/2 HP Electric Motor
- Q019 - Control Board Non UL (Not Shown)
- Q025 - Motor Pulley (ID5/8)
- Q027 - Motor Capacitor
- Q029 - Limit Switch (One)
- Q044 - Chain No. 50
- Q045 - Drive Belt 1/2 HP 4L190
- Q046 - Gear Reducer Pulley
- Q059 - Output Arm Solid
- Q062 - Cludge Cover - Stainless Steel
- Q084 - Emergency Key Release
- Q118 - Key for Access Door
- Q175 - Belt UL DM/1 HP
- Q183 - Sprocket (B50-16)
- Q212 - Gear Reducer 40-30:1
- Q216 - Output Shaft for 70 Reducer
- Q220 - CSW200UL™ Chassis for 70 Reducer
- Q244 - Cover - HD Polyethylene
- Q247 - Cover - DM HD Polyethylene
- Q268 - Cludge Cover - Plastic
- Q269 - Stainless Steel Cover
- Q400E-1 - Omni Main PCB (OmniControl™)
- Q401 - Omni 1 Horsepower Board
- Q404 - Omni Alarm
- Q407 - Omni Motor Harness 1HP
- Q408 - Electronic Power Strip
- Q409 - Electronic Access Panel
- Q410 - Surge Suppressor Terminal Block
- Q520 - Omni Motor Harness
- Q521 - Omni Motor Harness DM

NOTE: **Assembly Parts Number**

Accessories

Standard Arm
Part # Q104

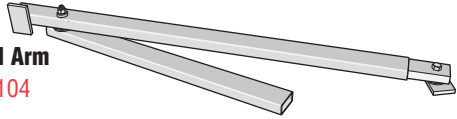

Swivel Arm
Part # Q103

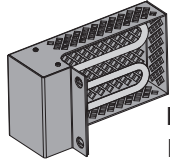
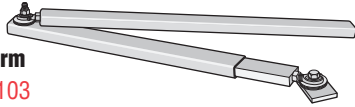

Heater Kit
Part # G6518CSW

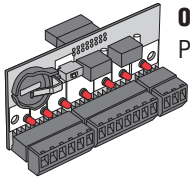

OmniControl™ Board
Part # OOMNIEXB

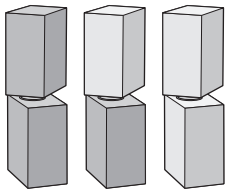

Power Hinges

UL Approved Round Sensing Edge

Part # G65MGR20x
x= length (4, 5, 6, 8 ft)
(e.g. G65MGR206 is 6 ft)



UL Approved Square Sensing Edge

Part # G65MGS20x
x= length (4, 5, 6, 8 ft)
(e.g. G65MGS204 is 4 ft)

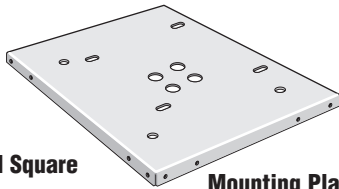

Mounting Plate
Part # MPEL



DC2000™ Kit
Part # ODC2000CSW



Plug-In Loop Detector
Part # AELD



110Vac External Loop Detector
Part # A79

For more information about accessories:
www.chamberlain.com

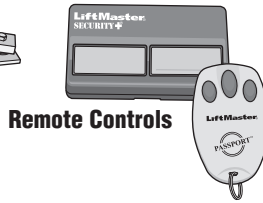

Remote Controls



Omni Relay Adapter
Part # Q400MAU

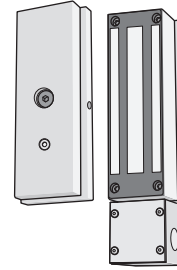

Magnetic Lock (Outdoor)
Part # MG1300

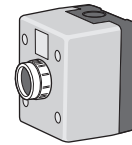

Stop Button
Part # AEXITP

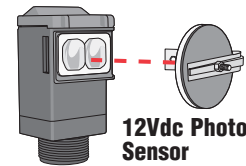

12Vdc Photoelectric Sensor
Part # AOMRON



3-Button Control Station
Part # 02-103

LiftMaster SECURITY+



Mini 3 Button
Part # 370LM



Part # 371LM



Part # 373LM



Part # 372LM



Part # 374LM

LiftMaster



Part # CPT13



Part # CPT33



Mini 3 Button
Part # CPTK33



Part # CPT23



Part # CPT43



Mini 3 Button with HID Prox, Sensor
Part # CPTK33PH

System Diagram



System Diagram



System Diagram



Installation Checklist

1. Owner and Installer must read all warnings and safety precautions.
2. Make sure concrete mounting pad is big enough and deep enough for operator.
3. Operator must be **securely** fastened to concrete pad or mounting plate.
4. Operator arm must be **level** and welded properly to gate.
5. Rectangular tubes on operator arm must be **completely** welded around.
6. When gate is pulled, **No** slippage of operator arm should occur.
7. Gate operator to be grounded to an earth ground rod within 3 feet of operator.
8. Verify that AC power is connected properly and **Property Owner** knows how to shut off power to operator.
9. Verify that the gate opens and closes as needed.
10. When gate hits object during operation, it **must** stop or reverse direction.
11. **Know how to operate the emergency manual release.**
12. Make sure that any pinch point or potential entrapment are guarded by means of safety devices or like.
13. Warning placards need to be permanently mounted on **both** sides of gate.
14. Test all additional equipment connected to operator.
15. Make sure all wire connections are **securely** fastened.
16. Review typical maintenance on operator.
17. Schedule periodic maintenance on operator by qualified service technician.
18. Inquire about Manufacturers “operator warranty.” (Warranty Card included with operator.)
19. Inquire about **separate** “installation warranty” with installer.

Installer Company Name, Address and Phone Number

Date Installed: _____

Warranty Policy

7 YEAR RESIDENTIAL / 5 YEAR COMMERCIAL CSW200UL™ LIMITED WARRANTY

The Chamberlain Group, Inc. (“Seller”) warrants to the first purchaser of this product, for the structure in which this product is originally installed, that it is free from defect in materials and/or workmanship for a period of 7 year residential/ 5 year commercial from the date of purchase [and that the CSW200UL™ is free from defect in materials and/or workmanship for a period of 7 year residential/ 5 year commercial from the date of purchase]. The proper operation of this product is dependent on your compliance with the instructions regarding installation, operation, maintenance and testing. Failure to comply strictly with those instructions will void this limited warranty in its entirety.

If, during the limited warranty period, this product appears to contain a defect covered by this limited warranty, call **1-800-528-2806**, toll free, before dismantling this product. Then send this product, pre-paid and insured, to our service center for warranty repair. You will be advised of shipping instructions when you call. Please include a brief description of the problem and a dated proof-of-purchase receipt with any product returned for warranty repair. Products returned to Seller for warranty repair, which upon receipt by Seller are confirmed to be defective and covered by this limited warranty, will be repaired or replaced (at Seller’s sole option) at no cost to you and returned pre-paid. Defective parts will be repaired or replaced with new or factory-rebuilt parts at Seller’s sole option.

ALL IMPLIED WARRANTIES FOR THE PRODUCT, INCLUDING BUT NOT LIMITED TO ANY IMPLIED WARRANTIES OF MERCHANTABILITY AND FITNESS FOR A PARTICULAR PURPOSE, ARE LIMITED IN DURATION TO THE 7 YEAR RESIDENTIAL/ 5 YEAR COMMERCIAL LIMITED WARRANTY PERIOD SET FORTH ABOVE [EXCEPT THE IMPLIED WARRANTIES WITH RESPECT TO THE CSW200UL™, WHICH ARE LIMITED IN DURATION TO THE 7 YEAR RESIDENTIAL/ 5 YEAR COMMERCIAL LIMITED WARRANTY PERIOD FOR THE CSW200UL™], AND NO IMPLIED WARRANTIES WILL EXIST OR APPLY AFTER SUCH PERIOD. Some states do not allow limitations on how long an implied warranty lasts, so the above limitation may not apply to you. THIS LIMITED WARRANTY DOES NOT COVER NON-DEFECT DAMAGE, DAMAGE CAUSED BY IMPROPER INSTALLATION, OPERATION OR CARE (INCLUDING, BUT NOT LIMITED TO ABUSE, MISUSE, FAILURE TO PROVIDE REASONABLE AND NECESSARY MAINTENANCE, UNAUTHORIZED REPAIRS OR ANY ALTERATIONS TO THIS PRODUCT), LABOR CHARGES FOR REINSTALLING A REPAIRED OR REPLACED UNIT, OR REPLACEMENT OF BATTERIES.

THIS LIMITED WARRANTY DOES NOT COVER ANY PROBLEMS WITH, OR RELATING TO, THE GARAGE DOOR OR GARAGE DOOR HARDWARE, INCLUDING BUT NOT LIMITED TO THE DOOR SPRINGS, DOOR ROLLERS, DOOR ALIGNMENT OR HINGES. THIS LIMITED WARRANTY ALSO DOES NOT COVER ANY PROBLEMS CAUSED BY INTERFERENCE. ANY SERVICE CALL THAT DETERMINES THE PROBLEM HAS BEEN CAUSED BY ANY OF THESE ITEMS COULD RESULT IN A FEE TO YOU.

UNDER NO CIRCUMSTANCES SHALL SELLER BE LIABLE FOR CONSEQUENTIAL, INCIDENTAL OR SPECIAL DAMAGES ARISING IN CONNECTION WITH USE, OR INABILITY TO USE, THIS PRODUCT. IN NO EVENT SHALL SELLER’S LIABILITY FOR BREACH OF WARRANTY, BREACH OF CONTRACT, NEGLIGENCE OR STRICT LIABILITY EXCEED THE COST OF THE PRODUCT COVERED HEREBY. NO PERSON IS AUTHORIZED TO ASSUME FOR US ANY OTHER LIABILITY IN CONNECTION WITH THE SALE OF THIS PRODUCT.

Some states do not allow the exclusion or limitation of consequential, incidental or special damages, so the above limitation or exclusion may not apply to you. This limited warranty gives you specific legal rights, and you may also have other rights which vary from state to state.

CHAMBERLAIN®

ELITE™

CSW200UL™



UL325 UL991
compliant compliant



845 Larch Avenue
Elmhurst, Illinois 60126-1196