

DXT-41 DXT-42

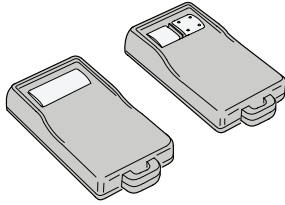

MINI TRANSMITTERS

Operation Instructions

For more information:
www.devancocanada.com
 or call toll free at 855-931-3334

Linear

PRODUCT DESCRIPTION

The DXT-41, DXT-42 are battery powered, portable, miniature transmitters designed for use with Linear's DX Format receivers. Each transmitter can be used in a limitless number of wireless remote control applications. Pressing a button on the transmitter sends a digitally coded wireless signal to its companion receiver. The digital DX code format features over a million possible codes. The DX transmitters are precoded at the factory to unique codes, so no field coding is required. The two-button transmitter sends variations of its preset code depending on which buttons are pressed. Transmitters can send a signal for up to 10 seconds with each single-button activation.

For versatility, any transmitter code can be programmed into any receiver channel. Receivers must be programmed to the transmitter code before system testing and operation. DX Format digital receivers are programmed by "Learning" the preset factory code from the transmitter. Refer to the receiver's instructions for details on programming.

Each transmitter is powered from two 3-Volt Type 1620 lithium batteries with an expected battery life of up to 5 years. When the transmitter's range decreases, or stops functioning, replace the batteries.

A detachable key-ring is provided for each transmitter. Each transmitter button has a positive "click" feel. The right button on the DXT-42 has raised bumps for easy identification.

TRANSMITTER CONFIGURATIONS

DXT-41

The DXT-41 is a one-button, one-code transmitter. Pressing the button sends the transmitter's code to the receiver. Press the button for a minimum of two seconds to insure receiver activation.

DXT-42

The DXT-42 is a two-button, three-code transmitter. Each button sends a unique code. Pressing both buttons **together** sends code three. Press button(s) for a minimum of two seconds to insure receiver activation.

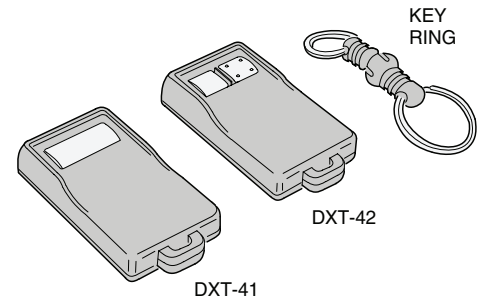

DXT-41 FEATURES

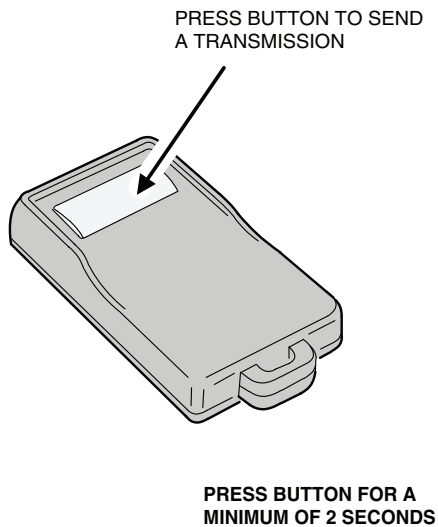

DXT-42 FEATURES

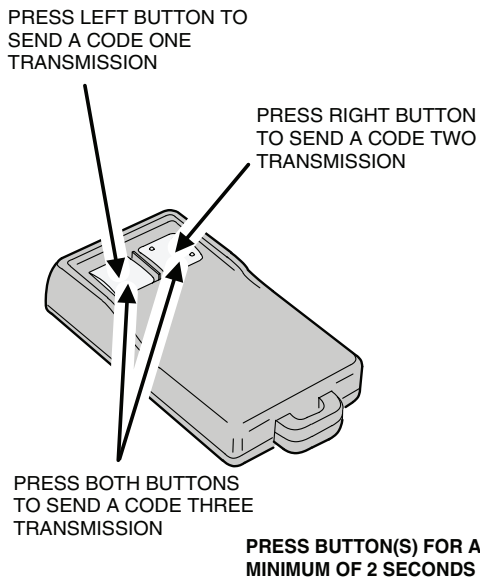

BATTERY REPLACEMENT STEP 1

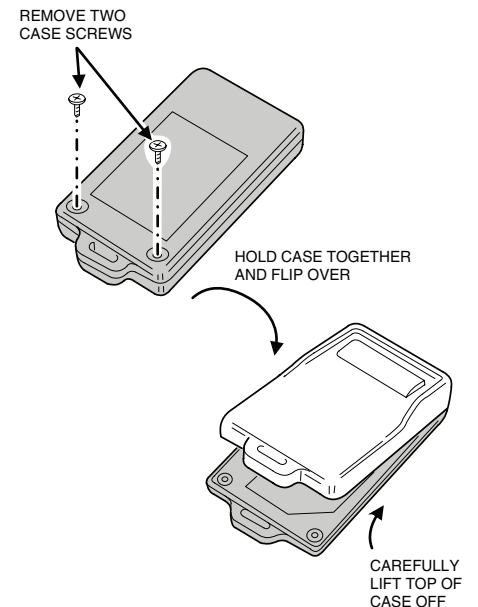

BATTERY REPLACEMENT STEP 2

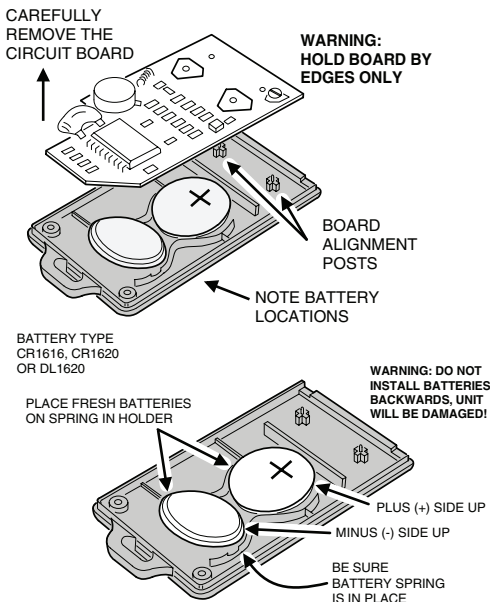

BATTERY REPLACEMENT STEP 3

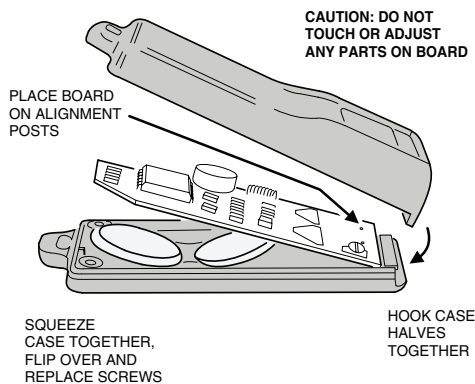

FCC NOTE:

This device complies with FCC Part 15. Operation is subject to the following two conditions: (1) This device may not cause harmful interference and (2) this device must accept any interference received, including interference that may cause undesired operation.

LINEAR LIMITED WARRANTY

This Linear product is warranted against defects in material and workmanship for twelve (12) months. The Warranty Expiration Date is labeled on the product. **This warranty extends only to wholesale customers who buy direct from Linear or through Linear's normal distribution channels. Linear does not warrant this product to consumers.** Consumers should inquire from their selling dealer as to the nature of the dealer's warranty, if any. **There are no obligations or liabilities on the part of Linear Corporation for consequential damages arising out of or in connection with use or performance of this product or other indirect damages with respect to loss of property, revenue, or profit, or cost of removal, installation, or reinstallation.** All implied warranties, including implied warranties of merchantability and implied warranties of fitness, are valid only until Warranty Expiration Date as labeled on the product. **This Linear Corporation Warranty is in lieu of all other warranties express or implied.**

All products returned for warranty service require a Return Product Authorization Number (RPA#). Contact Linear Technical Services at 1-800-421-1587 for an RPA# and other important details.

IMPORTANT !!!

Linear radio controls provide a reliable communications link and fill an important need in portable wireless signalling. However, there are some limitations which must be observed.

- * For U.S. installations only: The radios are required to comply with FCC Rules and Regulations as Part 15 devices. As such, they have limited transmitter power and therefore limited range.
- * A receiver cannot respond to more than one transmitted signal at a time and may be blocked by radio signals that occur on or near their operating frequencies, regardless of code settings.
- * Changes or modifications to the device may void FCC compliance.
- * Infrequently used radio links should be tested regularly to protect against undetected interference or fault.
- * A general knowledge of radio and its vagaries should be gained prior to acting as a wholesale distributor or dealer, and these facts should be communicated to the ultimate users.

***HOW TO ORDER
REPAIR PARTS***

DEVANCO CANADA

19192 HAY ROAD, UNIT Q
SUMMERSTOWN, ON K0C 2E0

TOLL FREE: 855-931-3334

www.devancocanada.com

**WHEN ORDERING REPAIR PARTS
PLEASE SUPPLY THE
FOLLOWING INFORMATION:**

- ✓ PART NUMBER
- ✓ DESCRIPTION
- ✓ MODEL NUMBER