

TL70 Modular Tower Light



Datasheet



Banner's TL70 Tower Light is a 70 mm, modular LED indicator with extremely bright and uniform light. The modularity gives the user flexibility to customize tower lights as needed and change positions in the field. The TL70 is also available preassembled for easy installation.

- Light segments have user-selectable solid ON or flashing
- Up to five colors plus audible in one device
- Rugged, water-resistant IP65 housing with UV-stabilized material
- Bright, uniform indicator segments appear gray when off to eliminate false indication from ambient light
- Several connection options to choose from including M12/Euro-style quick disconnect, cabled, and terminal-wired

Models Key

TL70 Base

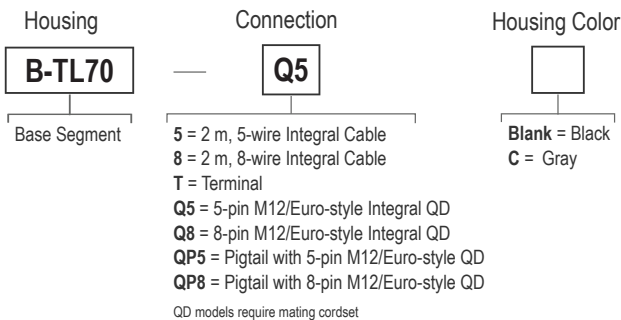

TL70 Segments

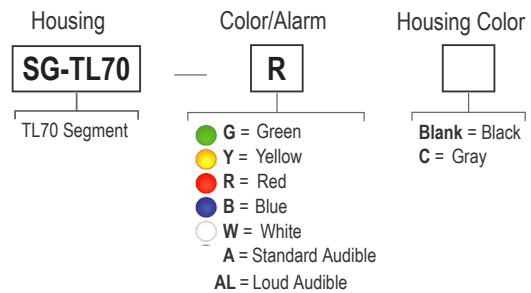

Select the 5-pin base for tower light configurations of up to 4 modules. Select the 8-pin base for tower light configurations of up to 6 modules.

- Example base model number: B-TL70-Q5
- Example light segment model number: SG-TL70-G
- Example audible segment model number: SG-TL70-A

TL70 Pre-Assembled Models

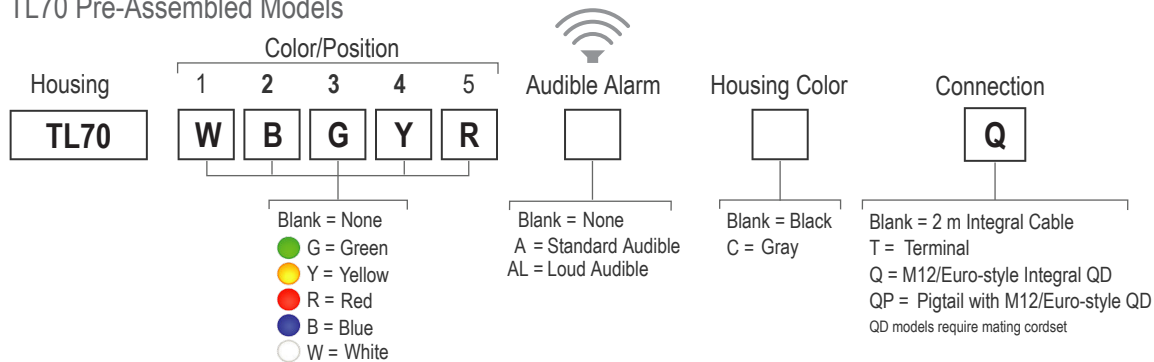

- Example pre-assembled model number: TL70GYRAQ.

Use a 5-pin cordset for 1 to 4 modules. Use a 8-pin cordset for 5 or 6 modules.

Configuring the Modules



Turn on the appropriate DIP switch to set the order of the components, counting up from the tower light's base.

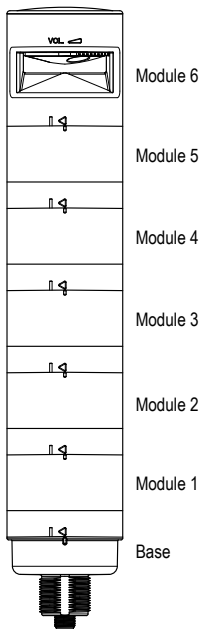

Assembly Options		DIP Switches							
		1	2	3	4	5	6	7	8
Light and Standard Audible Components	Module 1	ON							
	Module 2		ON						
	Module 3			ON					
	Module 4				ON				
	Module 5					ON			
	Module 6						ON		

Light Module Flash Rate	3 Hz							ON	OFF
	1.5 Hz							ON	ON
	Solid On*							OFF	OFF

Standard Audible Module Settings	Pulse 1.5 Hz							ON	OFF
	Chirp Alarm							ON	ON
	Siren Alarm							OFF	ON
	Continuous Alarm*							OFF	OFF

Assembly Options		DIP Switches									
		1	2	3	4	5	6	7	8	9	10
Loud Audible Module Settings	Pulse 1.5 Hz							ON	OFF		
	Chirp Alarm							ON	ON		
	Siren Alarm							OFF	ON		
	Continuous Alarm*							OFF	OFF		
	Low Intensity									OFF	OFF
	Med. Intensity									ON	OFF
	Med./Loud Intensity									OFF	ON
	Loud Intensity									ON	ON

* Factory default setting

Assembling the Modules

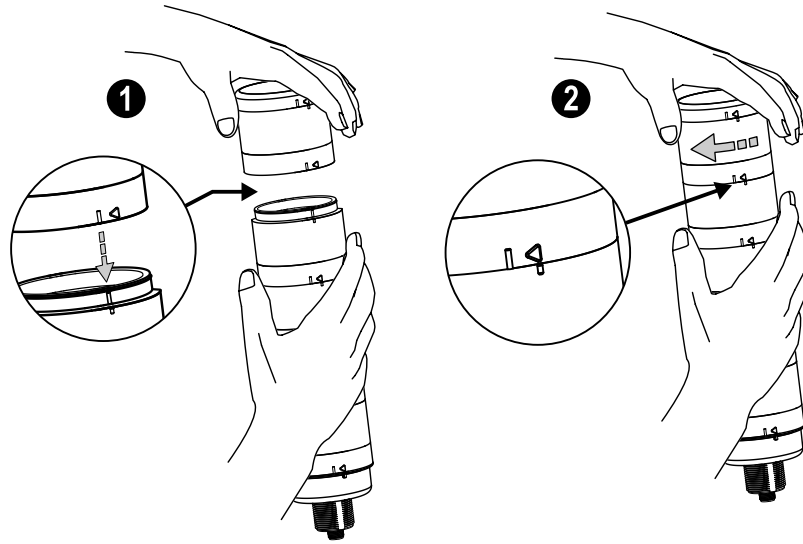

To assemble the modules:

1. Align the notches on each module.
2. Press together.
3. Rotate the top module clockwise to lock into place (notches shown in the locked position).

Specifications

Supply Voltage and Current
12 to 30 V dc

Indicator Color or Audible Model	Maximum Current (mA)	
	at 12 V dc	at 30 V dc
Blue, Green, White	420	145
Red, Yellow	285	120
Standard Audible	30	30
Loud Audible (Intensity 1)	18	14
Loud Audible (Intensity 2)	40	28
Loud Audible (Intensity 3)	160	70
Loud Audible (Intensity 4)	350	110

Supply Protection Circuitry

Protected against transient voltages

Indicator Response Time

Off Response: 150 μ s (maximum) at 12 to 30 V dc

On Response: 180 ms (maximum) at 12 V dc; 50 ms (maximum) at 30 V dc

Standard Audible Adjustment

Mechanical adjustment: Rotate the cover until the desired volume is reached

Change in sound intensity from fully open to fully closed is 8 dB

Loud Audible Adjustment

Electronic adjustment: Select the desired volume using DIP switches 9 and 10

Change in sound intensity from maximum to minimum is 16 dB

Construction

Bases, segments, covers: polycarbonate

Indicators

1 to 5 colors depending on model: Green, Red, Yellow, Blue, and White

Flash rates: 1.5 Hz \pm 10% and 3 Hz \pm 10%

LEDs are independently selected

Terminal Block Model

14 to 28 AWG wire

Connections

5-pin M12/Euro-style quick disconnect connector, 8-pin M12/Euro-style quick disconnect connector, 150 mm (5.9 in) PVC cable with an M12/Euro-style quick disconnect connector, terminal block, or 2 m (6.5 ft) unterminated cable, depending on model

Alarm

Standard Audible: 2.6 kHz ± 250 Hz oscillation frequency; maximum intensity (typical) 92 dB at 1 m (3.3 ft)
 Loud Audible: 2.6 kHz ± 250 Hz oscillation frequency; maximum intensity (typical) at 1 m (3.3 ft) (see table)

DIP Switches		Max Intensity (Loud Audible)
9	10	
ON	ON	Intensity 4: 101 dB
OFF	ON	Intensity 3: 99 dB
ON	OFF	Intensity 2: 92 dB
OFF	OFF	Intensity 1: 85 dB

Operating Conditions

-40 °C to +50 °C (-40 °F to +122 °F)
 95% at +50 °C maximum relative humidity (non-condensing)

Environmental Rating

IEC IP65

Vibration and Mechanical Shock

Vibration 10 to 55 Hz 0.5 mm p-p amplitude per IEC60068-2-6
 Shock 15G 11 ms duration, half sine wave per IEC60068-2-27

Certifications

Standard Audible:



Loud Audible:

Approvals are pending

Segment Lumens

Color	Typical Wavelength or Color Temp	Typical Intensity (lm)
Green	525 nm	92
Red	625 nm	40
Yellow	590 nm	22
Blue	470 nm	32
White	5000 K	125

Dimensions

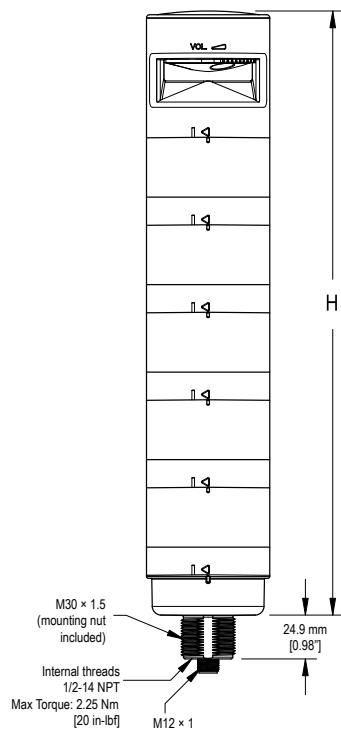

Model	Height (H)
1 light module	87.6 mm (3.45 in)
1 light module, 1 audible module	144.3 mm (5.68 in)
2 light modules	137.3 mm (5.41 in)
2 light modules, 1 audible module	194 mm (7.64 in)
3 light modules	187 mm (7.36 in)
3 light modules, 1 audible module	243.7 mm (9.59 in)
4 light modules	236.7 mm (9.32 in)
4 light modules, 1 audible module	293.4 mm (11.55 in)
5 light modules	286.4 mm (11.28 in)
5 light modules, 1 audible module	343.1 mm (13.5 in)

Wiring Diagrams

Sourcing (PNP) Input	Sinking (NPN) Input	Euro-style Male Pinouts	Key
			<p>1 = brown 2 = white 3 = blue 4 = black 5 = gray</p> <p>M1 = Module 1 M2 = Module 2 M3 = Module 3 M4 = Module 4</p>
			<p>1 = white 2 = brown 3 = green 4 = yellow 5 = gray 6 = pink 7 = blue 8 = red</p> <p>M1 = Module 1 M2 = Module 2 M3 = Module 3 M4 = Module 4 M5 = Module 5 M6 = Module 6</p>
<p>Wiring Terminal Block</p>	<p>Terminal Block Key</p> <p>0 = dc common 1 = Module 1 2 = Module 2 3 = Module 3 4 = Module 4 5 = Module 5 6 = Module 6</p>		

Accessories

Cordsets

5-Pin Threaded M12/Euro-Style Cordsets—Single Ended				
Model	Length	Style	Dimensions	Pinout (Female)
MQDC1-501.5	0.50 m (1.5 ft)	Straight		<p>1 = Brown 2 = White 3 = Blue 4 = Black 5 = Gray</p>
MQDC1-506	1.83 m (6 ft)			
MQDC1-515	4.57 m (15 ft)			
MQDC1-530	9.14 m (30 ft)			
MQDC1-506RA	1.83 m (6 ft)	Right-Angle		
MQDC1-515RA	4.57 m (15 ft)			
MQDC1-530RA	9.14 m (30 ft)			

8-Pin Threaded M12/Euro-Style Cordsets with Open-Shield				
Model	Length	Style	Dimensions	Pinout (Female)
MQDC2S-806	1.83 m (6 ft)	Straight		<p>1 = White 2 = Brown 3 = Green 4 = Yellow 5 = Gray 6 = Pink 7 = Blue 8 = Red</p>
MQDC2S-815	4.57 m (15 ft)			
MQDC2S-830	9.14 m (30 ft)			
MQDC2S-850	15.2 m (50 ft)			
MQDC2S-806RA	1.83 m (6 ft)	Right-Angle		
MQDC2S-815RA	4.57 m (15 ft)			
MQDC2S-830RA	9.14 m (30 ft)			
MQDC2S-850RA	15.2 m (50 ft)			

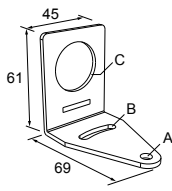
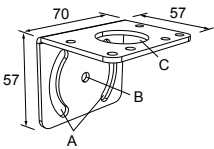
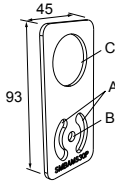
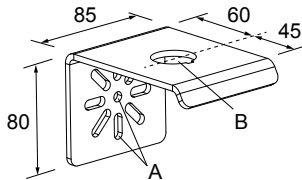

All measurements are listed in millimeters, unless noted otherwise.

Mounting Brackets

<p>SMB30A</p> <ul style="list-style-type: none"> • Right-angle bracket with curved slot for versatile orientation • Clearance for M6 (¼ in) hardware • Mounting hole for 30 mm sensor • 12-ga. stainless steel  <p>Hole center spacing: A to B=40 Hole size: A=∅ 6.3, B= 27.1 x 6.3, C=∅ 30.5</p>	<p>SMB30MM</p> <ul style="list-style-type: none"> • 12-ga. stainless steel bracket with curved mounting slots for versatile orientation • Clearance for M6 (¼ in) hardware • Mounting hole for 30 mm sensor  <p>Hole center spacing: A = 51, A to B = 25.4 Hole size: A = 42.6 x 7, B = ∅ 6.4, C = ∅ 30.1</p>
<p>SMBAMS30P</p> <ul style="list-style-type: none"> • Flat SMBAMS series bracket • 30 mm hole for mounting sensors • Articulation slots for 90°+ rotation • 12-ga. 300 series stainless steel  <p>Hole center spacing: A=26.0, A to B=13.0 Hole size: A=26.8 x 7.0, B=∅ 6.5, C=∅ 31.0</p>	<p>SSA-MBK-EEC1</p> <ul style="list-style-type: none"> • Single 30 mm hole • 8 gauge steel, black finish (zinc-plated) • Front surface for customer applied labels  <p>Hole size: A = ∅ 7 , B = ∅ 30</p>

All measurements are listed in millimeters, unless noted otherwise.

Elevated Mount System

Model	Features			Components			
SA-M30 - Black Polycarbonate	<ul style="list-style-type: none"> • Streamlined black PC or Gray PC thread cover • Covers M30 thread on the light base • Mounting hardware included 						
SA-M30C - Gray Polycarbonate							
<table border="1" style="width:100%; border-collapse: collapse;"> <tr> <td style="width:33%;">Polished 304 Stainless Steel</td> <td style="width:33%;">Black Anodized Aluminum</td> <td style="width:33%;">Clear Anodized Aluminum</td> </tr> </table>	Polished 304 Stainless Steel	Black Anodized Aluminum	Clear Anodized Aluminum	<ul style="list-style-type: none"> • Elevated-use stand-off pipe (½ in. NPSM/DN15) • Polished 304 stainless steel, black anodized aluminum, or clear anodized aluminum surface • ½ in. NPT thread at both ends • Compatible with most industrial environments 			
Polished 304 Stainless Steel	Black Anodized Aluminum	Clear Anodized Aluminum					
<table border="1" style="width:100%; border-collapse: collapse;"> <tr> <td style="width:33%;">SOP-E12-150SS 150 mm (6 in) long</td> <td style="width:33%;">SOP-E12-150A 150 mm (6 in) long</td> <td style="width:33%;">SOP-E12-150AC 150 mm (6 in) long</td> </tr> </table>	SOP-E12-150SS 150 mm (6 in) long	SOP-E12-150A 150 mm (6 in) long	SOP-E12-150AC 150 mm (6 in) long				
SOP-E12-150SS 150 mm (6 in) long	SOP-E12-150A 150 mm (6 in) long	SOP-E12-150AC 150 mm (6 in) long					
<table border="1" style="width:100%; border-collapse: collapse;"> <tr> <td style="width:33%;">SOP-E12-300SS 300 mm (12 in) long</td> <td style="width:33%;">SOP-E12-300A 300 mm (12 in) long</td> <td style="width:33%;">SOP-E12-300AC 300 mm (12 in) long</td> </tr> </table>	SOP-E12-300SS 300 mm (12 in) long	SOP-E12-300A 300 mm (12 in) long	SOP-E12-300AC 300 mm (12 in) long				
SOP-E12-300SS 300 mm (12 in) long	SOP-E12-300A 300 mm (12 in) long	SOP-E12-300AC 300 mm (12 in) long					
<table border="1" style="width:100%; border-collapse: collapse;"> <tr> <td style="width:33%;">SOP-E12-900SS 900 mm (36 in) long</td> <td style="width:33%;">SOP-E12-900A 900 mm (36 in) long</td> <td style="width:33%;">SOP-E12-900AC 900 mm (36 in) long</td> </tr> </table>	SOP-E12-900SS 900 mm (36 in) long	SOP-E12-900A 900 mm (36 in) long	SOP-E12-900AC 900 mm (36 in) long				
SOP-E12-900SS 900 mm (36 in) long	SOP-E12-900A 900 mm (36 in) long	SOP-E12-900AC 900 mm (36 in) long					
SA-E12M30 - Black Acetal	<ul style="list-style-type: none"> • Streamlined black acetal or white UHMW mounting base adapter/cover • Connects between ½ in. NPSM/DN15 pipe and 30 mm (1-3/16 in) drilled hole • Mounting hardware included 						
SA-E12M30C - White UHMW							

Pipe Mounting Flange			
Model	Features	Construction	
SA-F12	<ul style="list-style-type: none"> For use elevated stand-off pipes (1/2 in, NPSM/DN15) M5 mounting hardware and nitrile gasket included 	Die-cast zinc base with black paint	

Foldable Mounting Brackets			
Model	Features	Construction	
SA-FFB12	<ul style="list-style-type: none"> For use with 1/2 inch stand-off pipes Stainless steel hardware 	Black polycarbonate	
SA-FFB12C		Gray polycarbonate	

LMB Sealed Right-Angle Brackets

Model	Description	Construction	
LMB30RA	Direct-Mount Models: Bracket kit with base, 30 mm adapter, set screw, fasteners, o-rings, and gaskets	Black polycarbonate	
LMB30RAC		Gray polycarbonate	
LMBE12RA	Pipe-Mount Models: Bracket kit with base, 1/2-14 pipe adapter, set screw, fasteners, o-rings, and gaskets. For use with stand-off pipe (listed and sold separately)	Black polycarbonate	
LMBE12RAC		Gray polycarbonate	

Banner Engineering Corp. Limited Warranty

Banner Engineering Corp. warrants its products to be free from defects in material and workmanship for one year following the date of shipment. Banner Engineering Corp. will repair or replace, free of charge, any product of its manufacture which, at the time it is returned to the factory, is found to have been defective during the warranty period. This warranty does not cover damage or liability for misuse, abuse, or the improper application or installation of the Banner product.

THIS LIMITED WARRANTY IS EXCLUSIVE AND IN LIEU OF ALL OTHER WARRANTIES WHETHER EXPRESS OR IMPLIED (INCLUDING, WITHOUT LIMITATION, ANY WARRANTY OF MERCHANTABILITY OR FITNESS FOR A PARTICULAR PURPOSE), AND WHETHER ARISING UNDER COURSE OF PERFORMANCE, COURSE OF DEALING OR TRADE USAGE.

This Warranty is exclusive and limited to repair or, at the discretion of Banner Engineering Corp., replacement. IN NO EVENT SHALL BANNER ENGINEERING CORP. BE LIABLE TO BUYER OR ANY OTHER PERSON OR ENTITY FOR ANY EXTRA COSTS, EXPENSES, LOSSES, LOSS OF PROFITS, OR ANY INCIDENTAL, CONSEQUENTIAL OR SPECIAL DAMAGES RESULTING FROM ANY PRODUCT DEFECT OR FROM THE USE OR INABILITY TO USE THE PRODUCT, WHETHER ARISING IN CONTRACT OR WARRANTY, STATUTE, TORT, STRICT LIABILITY, NEGLIGENCE, OR OTHERWISE.

Banner Engineering Corp. reserves the right to change, modify or improve the design of the product without assuming any obligations or liabilities relating to any product previously manufactured by Banner Engineering Corp.